

Thermal Process Technology



Furnaces and Heat Treatment Plants for

Annealing, Hardening, Tempering

Forming, Preheating, Forging

Heat Cleaning

Vacuum Technology, Pyrolysis, Brazing

MIM, CIM, Debinding, Sintering

Additive Manufacturing, 3D-Printing

Plastics, Rubber, Silicone

Fiber Composites, GFRP, CFRP

Medtech

AMS 2750 E, NADCAP, CQI-9

Energy Efficiency Technology

www.nabertherm.com

■ Made
■ in
■ Germany



Made in Germany

Nabertherm with 450 employees worldwide have been developing and producing industrial furnaces for many different applications for over 60 years. As a manufacturer, Nabertherm offers the widest and deepest range of furnaces worldwide. 150,000 satisfied customers in more than 100 countries offer proof of our commitment to excellent design, quality and cost efficiency. Short delivery times are ensured due to our complete inhouse production and our wide variety of standard furnaces.

Setting Standards in Quality and Reliability

Nabertherm does not only offer the widest range of standard furnaces. Professional engineering in combination with inhouse manufacturing provide for individual project planning and construction of tailor-made thermal process plants with material handling and charging systems. Complete thermal processes are realized by customized system solutions.

Innovative Nabertherm control technology provides for precise control as well as full documentation and remote monitoring of your processes. Our engineers apply state-of-the-art technology to improve the temperature uniformity, energy efficiency, reliability and durability of our systems with the goal of enhancing your competitive edge.

Global Sales and Service Network – Close to you

Nabertherm's strength is one of the biggest R&D department in the furnace industry. In combination with central manufacturing in Germany and decentralized sales and service close to the customer we can provide for a competitive edge to live up to your needs. Long term sales and distribution partners in all important world markets ensure individual on-site customer service and consultation. There are various reference customers in your neighborhood who have similar furnaces or systems.

Large Customer Test Center

Which furnace is the right choice for this specific process? This question cannot always be answered easily. Therefore, we have set up our modern test center which is unique in respect to size and variety. A representative number of furnaces is available for tests for our customers.

Customer Service and Spare Parts

Our professional service engineers are available for you worldwide. Due to our complete inhouse production, we can despatch most spare parts from stock over night or produce with short delivery time.



Experience in Many Fields of Thermal Processing

In addition to furnaces for thermal process technology, Nabertherm offers a wide range of standard furnaces and plants for many other thermal processing applications. The modular design of our products provides for customized solutions to your individual needs without expensive modifications.

Table of Contents

	Page
Which Furnace for Which Process?	4
Additive Manufacturing, 3D-Printing	8
Plastics	9
Brazing, Forming	10
Retort Furnaces, Clean Room Solutions	
Hot-wall retort furnaces up to 1100 °C	12
Cold-wall retort furnaces up to 2400 °C	16
Pit-type cold-wall retort furnaces up to 2400 °C or up to 3000 °C	20
Bottom loading retort furnace up to 2400 °C.....	21
Retort furnaces for catalytic debinding also as combi furnaces for catalytic or thermal debinding.....	22
Clean room solutions	23
Forced Convection Furnaces	
Forced convection chamber furnaces < 675 liters, electrically heated	24
Forced convection chamber furnaces > 1000 liters, electrically heated or gas-fired.....	26
Chamber dryers, electrically heated or gas-fired	32
Ovens, also with safety technology according to EN 1539, electrically heated	36
Forced convection chamber furnaces/dryers with safety technology for solvent-containing charges according to EN 1539 or NFPA 86	38
Forced convection pit-type furnaces, electrically heated or gas-fired	39
Pit-type and top-loading furnaces with or without air circulation, electrically heated or gas-fired	41
Forced convection bogie hearth furnaces, electrically heated or gas-fired.....	42
Bogie Hearth Furnaces	
Bogie hearth furnaces, electrically heated	44
Gas-fired bogie hearth furnaces up to 1400 °C for firing or sintering in air or under reducing atmosphere	47
Chamber Furnaces	
Chamber furnaces, gas-fired.....	48
Chamber furnaces, electrically heated.....	49
Chamber furnaces, Sheet metal preheating furnaces, electrically heated.....	50
Chamber furnaces for heat cleaning, gas-fired with integrated thermal afterburner	52
Chamber furnaces for processes with high vaporization rates of organic matter or for thermal cleaning by ashing, electrically heated or gas-fired	53
Top Hat Furnaces or Bottom Loading Furnaces with Wire Heating up to 1400 °C	54
Charging Devices and Accessories for Chamber and Bogie Hearth Furnaces	56
Quench Tanks	57
Protective Gas and Carburization Systems for Annealing and Hardening	58
Salt-Bath Furnaces for Heat Treatment of Steel or Light Metals, Electrically Heated or Gas-Fired	60
Martempering Furnaces Using Neutral Salts, Electrically Heated	61
Furnaces for Continuous Processes	
Rotary hearth furnaces up to 1300 °C with and without air circulation, electrically heated or gas-fired	62
Continuous furnaces, electrically heated or gas-fired.....	64
Wire and strand annealing furnaces	68
Energy Efficiency Technology	69
Tempering Plants for Aluminium and Steel	70
Temperature Uniformity and System Accuracy	76
AMS 2750 E, NADCAP, CQI-9	77
Process Control and Documentation	80



Which Furnace for Which Process?

Preheating for Forging

- Press Hardening
- Heating of sheet metals
- Preheating of molds

Hardening, Annealing

- Ageing
- Austempering
- Diffusion annealing
- Pack hardening
- Recovery annealing
- Coarse grain annealing
- Hardening
- Solution annealing
- Annealing
- Recrystallization annealing
- Stress-relieving
- Soft annealing

Quenching

- Water
- Air
- Oil
- Polymer



in Air

under Protective Gases, Reaction Gases or in Vacuum

in Salt Bath

Bogie hearth furnaces
page 44

Forced convection pit-type
furnaces
page 40

Hot-wall retort furnaces
page 12 - 15

Salt-bath furnaces
page 60

Quench tanks
page 57

Bogie hearth furnaces
gas-fired
page 47

Pit-type and top-loading
furnaces
page 41

Cold-wall retort furnaces
page 16 - 21

Water quench tanks
page 72 - 75

Chamber furnaces
gas-fired
page 48

Bogie hearth furnaces
page 44

Bogie hearth furnaces with
annealing box
page 44

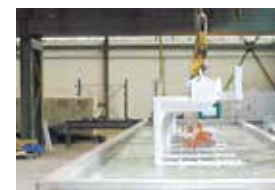

Chamber furnaces
page 49/50

Bogie hearth furnaces
gas-fired
page 47

Chamber furnaces with
annealing box
page 49

Salt-bath furnace TS 40/30
with exhaust gas collection at
crucible rim see page 60

Water quench tank with powerful
water-circulation

Top hat furnaces
page 54

Chamber furnaces
gas-fired
page 48

Top hat furnaces with
annealing box
page 54

Rotary hearth furnaces
page 62

Chamber furnaces
page 49/50

Rotary hearth furnaces
page 62

Continuous furnaces
page 64

Top hat furnaces
page 54

Rotary hearth furnaces
page 62

Continuous furnaces
page 64

Strand annealing furnaces
page 68

Wire annealing furnaces
page 68



Annealing furnace with electro-hydraulic lift door on portable base for preheating of large steel sheets for the automotive industry see page 50



NRA 480/04S see page 12

Tempering, Annealing

Tempering Plants

- Tempering
- Precipitation annealing
- Ageing annealing
- Recovery annealing
- Solution annealing
- Preheating
- Reduced hydrogen annealing

- Solution annealing
- Quenching
- Artificial ageing

in Air

under Protective Gases, Reaction Gases or in Vacuum

in Salt Bath

Tempering Plants

- Chamber dryers
page 32
- Forced convection chamber furnaces > 560 liters
page 26
- Forced convection chamber furnaces < 675 liters
page 24
- Forced convection chamber furnaces with clean room technology, page 23
- Forced convection bogie hearth furnaces with annealing box, page 25
- Forced convection chamber furnaces with clean room technology, page 23
- Forced convection bogie hearth furnaces with annealing box, page 42
- Forced convection bogie hearth furnaces
page 42
- Forced convection pit-type furnaces with annealing box, page 39
- Forced convection pit-type furnaces
page 39/40
- Pit-type and top-loading furnaces
page 41
- Rotary hearth furnaces
page 62
- Continuous furnaces
page 64

- Hot-wall retort furnaces
page 12 - 15
- Forced convection chamber furnaces with annealing box, page 25
- Forced convection chamber furnaces with clean room technology, page 23
- Forced convection bogie hearth furnaces with annealing box, page 42
- Forced convection pit-type furnaces with annealing box, page 39
- Rotary hearth furnaces
page 62
- Continuous furnaces
page 64

- Martempering furnaces
page 61

- Fully automatic tempering plant
page 72/73
- Manual tempering plant
page 74/75



Manual tempering plant for hardening of steel rods see page 74/75

Process flow chart

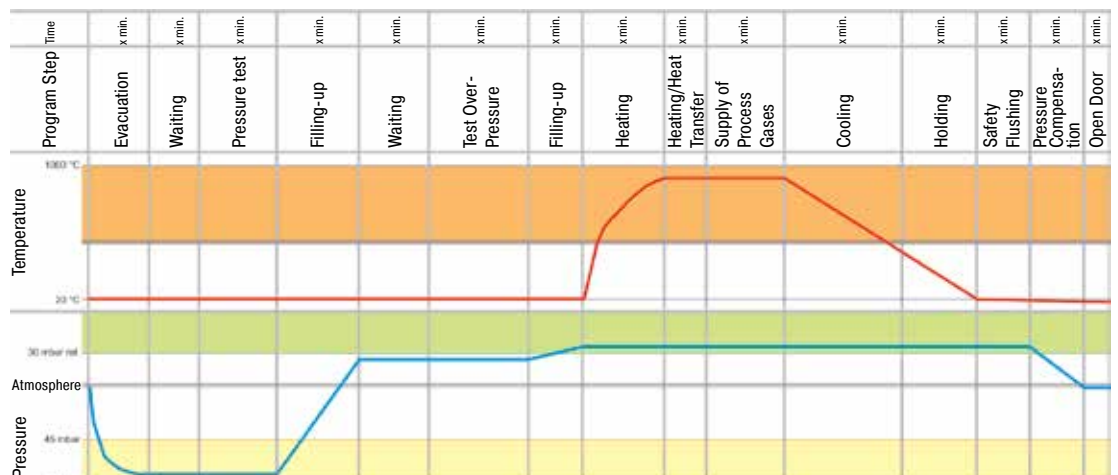

Which Furnace for Which Process?

Brazing/Soldering

Curing, Tempering, Drying

- Soft soldering
- Brazing
- High-temperature brazing
- Dip brazing of steel
- Dip brazing of aluminum

- Composites
- Molds
- Adhesive
- Plastics
- Lacquers
- PTFE
- Silicone
- Surface Drying
- Preheating
- Vulcanizing
- Conditioning

in Salt Bath

in Vacuum

under Protective Gases

Solvent Based

Water Based

Salt-bath furnaces
page 60

Hot-wall retort furnaces
page 12 - 15

Hot-wall retort furnaces
page 12 - 15

Hot-wall retort furnaces
page 12 - 15

Chamber dryers
page 32

Cold-wall retort furnaces
page 16 - 21

Cold-wall retort furnaces
page 16 - 21

Chamber dryers
page 32

Forced convection chamber furnaces
page 24

Forced convection chamber furnaces with annealing box, page 25

Forced convection chamber furnaces EN 1539
page 38

Ovens
page 36

Chamber furnaces with annealing box, page 49

Forced convection bogie hearth furnaces
page 42

Forced convection pit-type furnaces
page 39/40

Rotary hearth furnaces
page 62

Continuous furnaces
page 64

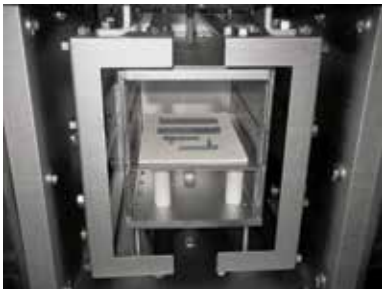

Sintering of MIM titan parts in a VHT furnace

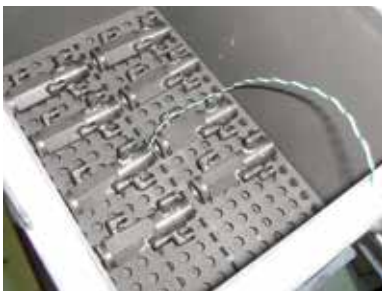

Brazing in a gas-supply box



VHT 500/22-GR H₂ with graphite insulation and heating see page 16

**Thermal/Thermo-Chemical Processes
 Surface Treatment, Cleaning**

**Sintering
 & Debinding**

- Carburizing
- Blueing (e.g. with water steam)
- Nitriding/nitrocarborizing
- Deoxidizing under hydrogen
- Pyrolysis
- Heat cleaning
- Oxidizing

- Debinding
- MIM
- CIM
- Sintering

in Powders

**under Protective
 Gases, Reaction Gases**

in Salt Bath

in Air

**under Protective Gases,
 Reaction Gases or in Vacuum**

Hot-wall retort furnaces page 12 - 15	Hot-wall retort furnaces page 12 - 15	Salt-bath furnaces page 60	Chamber furnaces NB .. CL, gas-fired page 52	Hot-wall retort furnaces page 12 - 15
Cold-wall retort furnaces page 16 - 21	Cold-wall retort furnaces page 16 - 21		Chamber furnaces N(B) .. BO page 53	Cold-wall retort furnaces page 16 - 21
Forced convection chamber furnaces page 24	Forced convection chamber furnaces with annealing box, page 25		Forced convection chamber furnaces N .. LS page 38	Retort furnaces for catalytic debinding page 22
Bogie hearth furnaces page 44	Forced convection bogie hearth furnaces with annealing box, page 42			
Bogie hearth furnaces gas-fired page 47	Bogie hearth furnaces with annealing box page 44			
Chamber furnaces gas-fired page 48	Chamber furnaces with annealing box page 49			
Chamber furnaces page 49/50	Overview annealing boxes page 58			
Top hat furnaces page 54				
Overview annealing boxes page 58				

Thermal Separation Processes

Process	..DB.. Debinding and sintering in oxidising atmosphere	..LS Debinding and sintering in oxidising atmosphere	..IDB.. Debinding inert atmos- phere	NB..CL Heat Clean- ing in inert atmosphere	..BO Heat Cleaning in oxidising atmosphere	NB..WAX Dewaxing and burn off
Avoid igniting	✓	✓	✓	✓		
Provoke igniting					✓	✓
Diluted atmosphere	✓	✓				
Inerted atmosphere			✓	✓		
Open combustion					✓	✓
O ₂ content	≥ 20 %	≥ 20 %	0-3 %	≤ 3 %	<> 20 % varies	<> 20 % varies
Vaporisation speed	slow	fast	slow	slow - fast	slow - fast	very fast
Loading / unloading	cold/cold	cold/cold hot/hot	cold/cold	cold/cold	cold/cold	> 750 °C/ > 750 °C
Tmax	1800 °C	450 °C	850 °C	500 °C	1400 °C	850 °C
Electrically heated	✓	✓	✓		✓	
Gas-fired				✓	✓	✓
External TNV	✓	(✓)	✓		✓	
Internal TNV				✓	✓	✓
External KNV	✓	(✓)	(✓)			



Blueing of drills in water steam atmosphere in a furnace of the NRA range see page 14

Additive Manufacturing, 3D-Printing



Retort furnace NR 150/11 for annealing of metal parts of 3D- printing

Additive manufacturing allows for the direct conversion of design construction files fully functional objects. With 3D-printing objects from metals, plastics, ceramics, glass, sand or other materials are built-up in layers until they have reached their final shape.

Depending on the material, the layers are interconnected by means of a binder system or by laser technology.

In most cases, these objects must be heat treated after printing. Nabertherm offers solutions from curing for conservation of the green strength up to vacuum furnaces in which the objects of metal are annealed or sintered.



Oven TR 240 for drying of powders



Chamber oven KTR 2000 for curing after 3D-printing



Compact tube furnace for sintering or annealing under protective gases or in a vacuum after 3D-printing



HT 160/17 DB200 for debinding and sintering of ceramics after 3D-printing

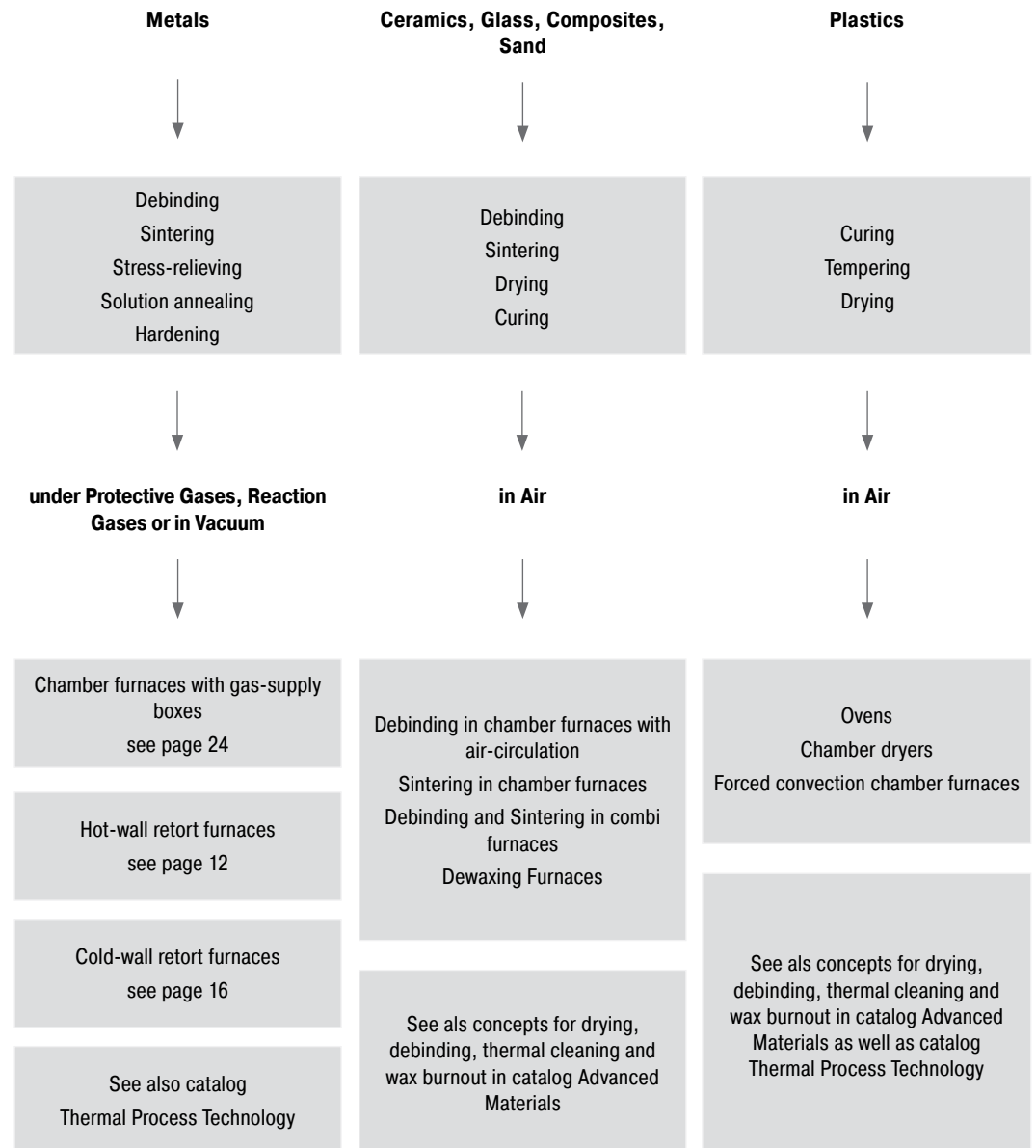

Also, concomitant or upstream processes of additive manufacturing require the use of a furnace in order to achieve the desired product properties, such as heat treatment or drying the powder.

Plastics

Tempering, Curing, Vulcanization and Degassing of Plastics, Rubber, Silicone, and Fiber Composite Materials

Many plastics and fiber composite materials must be heat-treated for product improvement or to ensure that they have the required product properties. In most cases, chamber dryers or furnaces with air circulation are used for the respective process. The following examples outline the processes which these furnaces can perform.

PTFE (polytetrafluoroethylene)

One application is the heat treatment of PTFE. This process can be used to improve the adhesive properties, the mixture hardness or the sliding properties of the coating. In most cases, chamber dryers are used which, depending on the type of plastic, may or may not include safety technology based on EN 1539.

Silicone

One reason why silicone is tempered is to reduce the amount of silicone oil in the silicone to a certain percentage, i.e. to drive it out, in order to meet relevant food regulations. During the tempering process the silicone oil is vented out of the furnace chamber by continuous air exchange. To optimize the temperature uniformity in the furnace chamber, the fresh air supply is preheated. Depending on the furnace size, a heat-recovery system with heat exchangers can result in significant energy savings and pay for itself in just a short time.

Parts are prevented from sticking together by keeping them moving in a rotating rack in the oven.

Carbon Composite Materials

These days, carbon composite materials are used in many industries such as automotive, aerospace, wind power, agriculture, etc. Different materials and manufacturing processes require different heat-treatment processes for curing composite materials.

Some of the processes are done in autoclaves. Other materials are heat-treated in chamber dryers or furnaces with air circulation. In this case, the composite materials are frequently evacuated in vacuum bags. For this purpose, the furnace is equipped with suitable connections for the evacuation of the air bags.

Pages 6/7 contain a description of which Nabertherm furnace ranges are suitable for tempering and curing of plastics.



Silicone tempering furnace with tightly welded inner box and rotating rack for the charge.



Continuous furnace D 1500/3000/300/14 with mesh belt transport system and subsequent cooling station

Brazing, Forming



Brazing in annealing box

The furnaces shown in this catalog can be used for various heat treatment processes. Nabertherm has developed interesting solutions for the processes described below as examples:

Brazing

In general, when speaking of brazing we have to distinguish between soft-soldering, brazing and high-temperature brazing. This involves a thermal process for forming substance-to-substance bonds and material coatings during which a liquid phase is generated by the melting of the solder. Based on their melting temperatures, the solder processes are classified as follows:

Soft-solders: $T_{liq} < 450\text{ °C}$

Brazing: $T_{liq} > 450\text{ °C} < 900\text{ °C}$

High-temperature brazing: $T_{liq} > 900\text{ °C}$



Hot-wall retort furnace to 1100 °C

Beside the right selection of the solder, the flux if necessary, and ensuring that the surfaces are clean, the choice of the right brazing furnace is also key to the process. In addition to the actual brazing process, Nabertherm has furnaces for the preparation process in their range such as for metallizing ceramics in preparation for brazing ceramic-to-metal bonds.

The following furnace concepts are available for brazing:

- Brazing in an annealing box in the forced convection chamber furnace up to 850 °C in a protective gas atmosphere
- Brazing in an annealing box in a chamber furnace up to 1100 °C under a protective gas atmosphere
- Brazing in a hot-wall retort furnace NR/NRA product line under protective gases or reaction gas up to 1100 °C
- Brazing in a cold-wall retort furnace VHT product line under protective gases, reaction gases or under vacuum up to 2200 °C
- Brazing in a salt bath up to 1000 °C salt bath temperature
- Brazing or metallizing in a tube furnace up to 1800 °C under protective gases, reaction gases or in a vacuum up to 1400 °C



N 6080/13 S with door-in-door function, isolating transformer and vibration dampers

In the Nabertherm Test Center in Lilienthal, Germany, a range of sample furnaces is available for customers testing applications which is the best approach to define the right furnace for a specific application.

Preheating for Hot Forming

For traditional hot forming processes such as forging or die forming the piece must first be heated to a defined temperature. From the manufacture of individual parts to serial production, from thin metal sheets to components which are formed in the course of multiple passes – Nabertherm offers a broad range of furnaces and special solutions for these processes.



N 1760/S for preheating sheet metal steel with charge support

If, for example, only the ends of long components need to be heated, the furnace can be fitted with closable openings in the door to avoid any heat losses. To protect the operator, an isolating transformer is used which safely conducts away the electrical currents in case of touching the heating elements.

If the furnace is used near a forging hammer which causes strong vibrations, vibration dampers can be installed to separate the furnace from these frequencies. The needs of continuous forging processes are met by appropriate furnace models such as rotary hearth furnaces and continuous furnaces. The advantage of the rotary hearth furnace is its compact size and the charging/discharging of the work piece at one position.



DH 2500/S on rails to shuttle between two forging stations

If the task is to form sheet steel, for example in the automotive industry, the furnace needs a large width and depth in relation to its height. For easy charging, the furnaces are provided with a lift door and can, if necessary, be fitted with a charge support adapted for use with the charging stacker.

Retort Furnaces



Retort furnace VHT 500/22-GR H₂ with CFC-process box and extension package for operation under hydrogen

Hot-Wall Retort Furnaces up to 1100 °C



Retort furnace NRA 25/06 with gas supply system



Retort furnace NRA 150/09 with automatic gas injection and process control H3700



Inside heating in retort furnace NRA ../06

These gas tight retort furnaces are equipped with direct or indirect heating depending on temperature. They are perfectly suited for various heat treatment processes requiring a defined protective or a reaction gas atmosphere. These compact models can also be laid out for heat treatment under vacuum up to 600 °C. The furnace chamber consists of a gas tight retort with water cooling around the door to protect the special sealing. Equipped with the corresponding safety technology, retort furnaces are also suitable for applications under reaction gases, such as hydrogen or, in combination with the IDB package, for inert debinding or for pyrolysis processes.

Different model versions are available depending on the temperature range required for the process:

Models NRA ../06 with Tmax 650 °C

- Heating elements located inside the retort
- Temperature uniformity up to +/- 5 °C inside the work space see page 76
- Retort made of 1.4571
- Gas circulation fan in the back of the retort provides for optimal temperature uniformity

Models NRA ../09 with Tmax 950 °C

- Outside heating with heating elements around the retort
- Temperature uniformity up to +/- 5 °C inside the work space see page 76
- Retort made of 1.4841
- Fan in the back of the retort provides for optimal temperature uniformity

Models NR ../11 with Tmax 1100 °C

- Outside heating with heating elements around the retort
- Temperature uniformity up to +/- 5 °C inside the work space see page 76
- Retort made of 1.4841



Bayonet quick-lock for the retort, also with electric drive as additional equipment



Parallel guided door to open the hot retort furnace as additional equipment



Retort furnace NRA 25/09



Retort furnace NRA 50/09 H₂

Basic version

- Compact housing in frame design with removable stainless steel sheets
- Controls and gas supply integrated in the furnace housing
- Welded charging supports in the retort or air-baffle box in the furnace with atmosphere circulation
- Swivel door hinged on right side with open cooling water system
- Depending on furnace volume for 950 °C- and 1100 °C-version the control system is divided in one or more heating zones
- Temperature control as furnace control with temperature measurement outside the retort
- Gas supply system for one non-flammable protective or reaction gas with flow meter and manual valve
- Port for vacuum pump for cold evacuation
- Operation under vacuum up to 600 °C with optional vacuum pumps
- Defined application within the constraints of the operating instructions
- NTLog Basic for Nabertherm controller: recording of process data with USB-flash drive
- Controls description see page 80



Vacuum pump for cold evacuation of the retort

Additional equipment

- Upgrade for other nonflammable gases
- Automatic gas injection, including MFC flow controller for alternating volume flow, controlled with process control H3700, H1700
- Vacuum pump for evacuating of the retort up to 600 °C, attainable vacuum up to 10⁻⁵ mbar subject to selected pump
- Cooling system for shortening process times
- Heat exchanger with closed-loop cooling water circuit for door cooling
- Measuring device for residual oxygen content
- Door heating
- Temperature control as charge control with temperature measurement inside and outside the retort
- Gas inlet with solenoid valve, controlled by the program
- Process control and documentation via VCD software package or Nabertherm Control Center (NCC) for monitoring, documentation and control see page 80

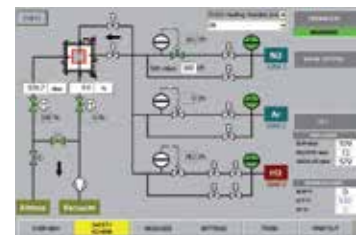

Process control H3700 for automatic version

Hot-Wall Retort Furnaces up to 1100 °C



Retort furnace NRA 300/09 H₂ for heat treatment under hydrogen



Charging of the NRA 300/06 retort furnace with a pallet truck

H₂ Version for Operation with Flammable Process Gases

When a flammable process gas like hydrogen is used, the retort furnace is additionally equipped with the required safety technology. Only certified and industry proven safety sensors are used. The furnace is controlled by a fail-safe PLC control system (S7- 300F/safety controller).

- Supply of flammable process gas at controlled overpressure of 50 mbar relative
- Certified safety concept
- PLC controls with graphic touch panel H3700 for data input
- Redundant gas inlet valves for hydrogen
- Monitored pre-pressures of all process gases
- Bypass for safe flushing of furnace chamber with inert gas
- Torch for thermal afterburning of exhaust gases
- Emergency flood container for purging the furnace in case of failure

IDB Version for Debinding under Non-flammable Protective Gases or for Pyrolysis Processes

The retort furnaces of the NR and NRA product line are perfectly suited for debinding under non-flammable protective gases or for pyrolysis processes. The IDB version of the retort furnaces implements a safety concept by controlled purging the furnace chamber with a protective gas. Exhaust gases are burned in an exhaust torch. Both the purging and the torch function are monitored to ensure a safe operation.

- Process control under monitored and controlled overpressure of 50 mbar relative
- Process control H1700 with PLC controls and graphic touch panel for data input
- Monitored gas pre-pressure of the process gas
- Bypass for safe flushing of furnace chamber with inert gas
- Torch for thermal afterburning of exhaust gases



Retort furnace NR 150/11 IDB with thermal afterburning system

Model	Tmax °C	Model	Tmax °C	Work space dimensions in mm			Useful volume in l	Electrical connection*
				w	d	h		
NRA 17/..	650 or 950	NR 17/11	1100	225	350	225	17	3-phase
NRA 25/..	650 or 950	NR 25/11	1100	225	500	225	25	3-phase
NRA 50/..	650 or 950	NR 50/11	1100	325	475	325	50	3-phase
NRA 75/..	650 or 950	NR 75/11	1100	325	700	325	75	3-phase
NRA 150/..	650 or 950	NR 150/11	1100	450	750	450	150	3-phase
NRA 200/..	650 or 950	NR 200/11	1100	450	1000	450	200	3-phase
NRA 300/..	650 or 950	NR 300/11	1100	590	900	590	300	3-phase
NRA 400/..	650 or 950	NR 400/11	1100	590	1250	590	400	3-phase
NRA 500/..	650 or 950	NR 500/11	1100	720	1000	720	500	3-phase
NRA 700/..	650 or 950	NR 700/11	1100	720	1350	720	700	3-phase
NRA 1000/..	650 or 950	NR 1000/11	1100	870	1350	870	1000	3-phase

*Please see page 81 for more information about supply voltage



Retort furnace SRA 300/06 with charging basket

The retort furnaces SR and SRA (with gas circulation) are designed for operation with non-flammable or flammable protective or reaction gases. The furnace is loaded from above by crane or other lifting equipment provided by the customer. In this way, even large charge weights can be loaded into the furnace chamber.

Depending on the temperature range in which the furnace be used, the following models are available:

Models SR .../11 with Tmax 1100 °C

- Heating from all sides outside the retort
- Temperature uniformity up to +/- 5 °C inside the work space see page 76
- Retort made of 1.4841
- Top down multi-zone control of the furnace heating

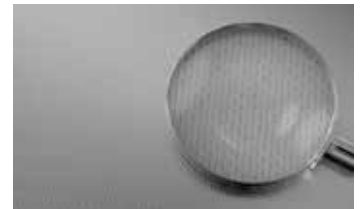

Front made of textured stainless steel

Models SRA/09 with Tmax 950 °C

Design like models SR.../11 with following differences:

- Atmosphere circulation with powerful fan in the furnace lid provides for temperature uniformity of up to +/- 5 °C inside the work space see page 76

Models SRA/06 with Tmax 600 °C

Design like models SRA.../09 with following differences:

- Heating inside the retort
- Temperature uniformity up to +/- 5 °C inside the work space see page 76
- Single-zone control
- Retort made of 1.4571

Standard Equipment (all models)

Design like standard equipment of models NR and NRA with following differences:

- Charging from above with crane or other lifting equipment from customer
- Hinged lid with opening to the side
- Defined application within the constraints of the operating instructions
- NTLog Basic for Nabertherm controller: recording of process data with USB-flash drive



Retort furnace SR 170/1000/11 with changeable retort and cooling station

Additional equipment, H₂ version or IDB version see models NR and NRA

Model	Tmax °C	Inner dimensions of alloy retort		Volume in l	Outer dimensions in mm			Electrical connection*	Weight in kg
		ø in mm	h in mm		W	D	H		
SR(A) 17/..	600, 950 or 1100	250	350	17	1300	1700	1800	3-phase	600
SR(A) 25/..		250	500	25	1300	1900	1800	3-phase	800
SR(A) 50/..		400	450	50	1400	2000	1800	3-phase	1300
SR(A) 100/..		400	800	100	1400	2000	2100	3-phase	1500
SR(A) 200/..		600	700	200	1600	2200	2200	3-phase	2100
SR(A) 300/..		600	1000	300	1600	2200	2500	3-phase	2400
SR(A) 500/..		800	1000	500	1800	2400	2700	3-phase	2800
SR(A) 600/..		800	1200	600	1800	2400	2900	3-phase	3000
SR(A) 800/..		1000	1000	800	2000	2600	2800	3-phase	3100
SR(A) 1000/..		1000	1300	1000	2000	2600	3100	3-phase	3300
SR(A) 1500/..		1200	1300	1500	2200	2800	3300	3-phase	3500

*Please see page 81 for more information about supply voltage



Retort furnace SRA 200/09

Cold-Wall Retort Furnaces up to 2400 °C



Retort furnace VHT 500/22-GR H₂ with CFC-process box and extension package for operation under hydrogen

The compact retort furnaces of the VHT product line are available as electrically heated chamber furnaces with graphite, molybdenum, tungsten or MoSi₂ heating. A wide variety of heating designs as well as a complete range of accessories provide for optimal retort furnace configurations even for sophisticated applications.

The vacuum-tight retort allows heat treatment processes either in protective and reaction gas atmospheres or in a vacuum, subject to the individual furnace specs to 10⁻⁵ mbar. The basic furnace is suited for operation with non-flammable protective or reactive gases or under vacuum. The H₂ version provides for operation under hydrogen or other flammable gases. Key of the specification up is a certified safety package providing for a safe operation at all times and triggers an appropriate emergency program in case of failure.

Alternative Heating Specifications

In general the following variants are available with respect to the process requirements:

VHT ...-GR with Graphite Insulation and Heating

- Suitable for processes under protective and reaction gases or under vacuum
- Tmax 1800 °C or 2200 °C (2400 °C as additional equipment)
- Max. vacuum up to 10⁻⁴ mbar depending on pump type used
- Graphite felt insulation

VHT ...-MO or VHT ...-W with Molybdenum or Tungsten Heating

- Suitable for high-purity processes under protective and reaction gases or under high vacuum
- Tmax 1200 °C, 1600 °C or 1800 °C (see table)
- Max. vacuum up to 10⁻⁵ mbar depending on pump type used
- Insulation made of molybdenum resp. tungsten radiation sheets

VHT ...-KE with Fiber Insulation and Heating through Molybdenum Disilicide Heating Elements

- Suitable for processes under protective and reaction gases, in air or under vacuum
- Tmax 1800 °C
- Max. vacuum up to 10⁻² mbar (up to 1300 °C) depending on pump type
- Insulation made of high purity aluminum oxide fiber



Retort furnace VHT 100/15-KE H₂ with fiber insulation and extension package for operation under hydrogen, 1500 °C



Heat treatment of copper bars under hydrogen in retort furnace VHT 8/16-MO

Standard Equipment for all Models

Basic version

- Standard furnace sizes 8 - 500 liters
- A water-cooled stainless steel process reactor sealed with temperature-resistant o-rings
- Frame made of stable steel profiles, easy to service due to easily removable stainless steel panels
- Housing of the VHT 8 model on castors for easy repositioning of furnace
- Cooling water manifold with manual stopcocks in supply and return lines, automatic flowmeter monitoring, openloop cooling water system
- Adjustable cooling water circuits with flowmeter and temperature indicator and overtemperature fuses
- Switchgear and controller integrated in furnace housing
- H700 process control with clearly laid out 7" touchpanel control for program entry and display, 10 programs each with 20 segments
- Over-temperature limiter with adjustable cutout temperature for thermal protection class 2 in accordance with EN 60519-2
- Manual operation of the process gas and vacuum functions
- Manual gas supply for one process gas (N₂, Ar or non-flammable forming gas) with adjustable flow
- Bypass with manual valve for rapid filling or flooding of furnace chamber
- Manual gas outlet with overflow valve (20 mbar relative) for over-pressure operation
- Single-stage rotary vane pump with ball valve for pre-evacuating and heat treatment in a rough vacuum to 5 mbar
- Pressure gauge for visual pressure monitoring
- Defined application within the constraints of the operating instructions
- NTLog Basic for Nabertherm controller: recording of process data with USB-flash drive

Additional equipment

- Tmax 2400 °C for VHT 40/...-GR and larger
- Housing, optionally divisible, for passing through narrow door frames (VHT 08)
- Manual gas supply for second process gas (N₂, Ar or non-flammable forming gas) with adjustable flow and bypass
- Inner process box made of molybdenum, tungsten, graphite or CFC, especially recommended for debinding processes. The box is installed in the furnace with direct gas inlet and outlet and provides for better temperature uniformity. Generated exhaust gases will be directly lead out the inner process chamber during debinding. The change of gas inlet pathes after debinding results in a cleaned process gas atmosphere during sintering.
- Charge thermocouple with display
- Temperature measurement at 2200 °C models with pyrometer and thermocouple, type S with automatic pull-out device for precise control results in the low temperature range (VHT 40/...-GR and larger)
- Two-stage rotary vane pump with ball valve for pre-evacuating and heat-treating in a fine vacuum (up to 10² mbar)
- Turbo molecular pump with slide valve for pre-evacuation and for heat treatment in a high vacuum (up to 10⁵ mbar) including electric pressure transducer and booster pump
- Other vacuum pumps on request
- Heat exchanger with closed-loop cooling water circuit
- Automation package with process control H3700
 - 12" graphic touch panel
 - Input of all process data like temperatures, heating rates, gas injection, vacuum at the touch panel
 - Display of all process-relevant data on a process control diagram
 - Automatic gas supply for one process gas (N₂, argon or non-flammable forming gas) with adjustable flow
 - Bypass for flooding and filling the chamber with process gas controlled by the program
 - Automatic pre- and post programs, including leak test for safe furnace operation
 - Automatic gas outlet with bellows valve and overflow valve (20 mbar relative) for over-pressure operation
 - Transducer for absolute and relative pressure
- Mass flow controller for alternating volume flow and generation of gas mixtures with second process gas (only with automation package)
- Partial pressure operation: protective gas flushing at controlled underpressure (only with automation package)
- Process control and documentation via VCD software package or Nabertherm Control Center (NCC) for monitoring, documentation and control see page 80



Graphite heating chamber



Molybdenum heating chamber



Tungsten heating chamber



Ceramic fiber insulation



Thermocouple, type S with automatic pull-out device for precise control results in the low temperature range



Retort furnace VHT 8/16-MO with automation package



Retort furnace VHT 40/22-GR with motor-driven lift door and front frame for connection to a glovebox



Turbo-molecular pump

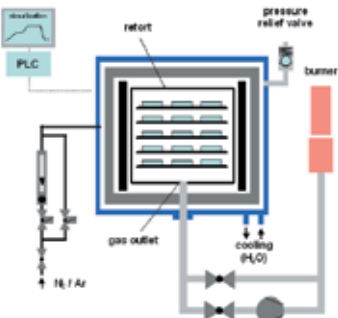

VHT gas supply diagram, debinding and sintering

H₂ Version for Operation with Hydrogen or other Reaction Gases

In the H₂ version the retort furnaces can be operated under hydrogen or other reaction gases. For these applications, the systems are additionally equipped with the required safety technology. Only certified and industry proven safety sensors are used. The retort furnaces are controlled by a fail-safe PLC control system (S7-300F/safety controller).

- Certified safety concept
- Automation package (additional equipment see page 17)
- Redundant gas inlet valves for hydrogen
- Monitored pre-pressures of all process gases
- Bypass for safe purging of furnace chamber with inert gas
- Pressure-monitored emergency flooding with automated solenoid valve opening
- Electric or gas-heated exhaust gas torch for H₂ post-combustion
- Atmospheric operation: H₂-purging of process reactor starting from room temperature at controlled over pressure (50 mbar relative)

Additional equipment

- Partial pressure operation: H₂ flushing at underpressure in the process reactor starting from 750 °C furnace chamber temperature
- Inner process hood in the process chamber for debinding under hydrogen
- Process control and documentation via Nabertherm Control Center (NCC) for monitoring, documentation and control see page 80



Single-stage rotary vane pump for heat treatment in a rough vacuum to 5 mbar



Two-stage rotary vane pump for heat treatment in a vacuum to 10⁻² mbar



Turbo-molecular pump with booster pump for heat treatment in a vacuum to 10⁻⁵ mbar

Process Box for Debinding in Inert Gas

Certain processes require charges to be debinded in non-flammable protective or reactive gases. For these processes we fundamentally recommend a hot-wall retort furnace (see models NR... or SR...). These retort furnaces can ensure that the formation of condensation will be avoided as thoroughly as possible.

If there is no way to avoid the escape of small amounts of residual binder during the process, even in the VHT furnace, the retort furnace should be designed to meet this contingency.

The furnace chamber is equipped with an additional process box that has a direct outlet to the exhaust gas torch through which the exhaust gas can be directly vented. This system enables a substantial reduction in the amount of furnace chamber contamination caused by the exhaust gases generated during debinding.

Depending on the exhaust gas composition the exhaust gas line can be designed to include various options.

- Exhaust gas torch for burning off the exhaust gas
- Condensation trap for separating out binding agents
- Exhaust gas post-treatment, depending on the process, via scrubbers
- Heated exhaust gas outlet to avoid condensation deposits in the exhaust gas line



Retort furnace VHT 40/16-MO H₂ with hydrogen extension package and process box

	VHT .../...-GR	VHT .../...-MO	VHT .../18-W	VHT .../18-KE
Tmax	1800 °C or 2200 °C	1200 °C or 1600 °C	1800 °C	1800 °C
Inert gas	✓	✓	✓	✓
Air/Oxygen	-	-	-	✓
Hydrogen	✓ ^{3,4}	✓ ³	✓ ³	✓ ^{1,3}
Rough vacuum and fine vacuum (>10 ⁻³ mbar)	✓	✓	✓	✓ ²
High vacuum (<10 ⁻³ mbar)	✓ ⁴	✓	✓	✓ ²
Material of heater	Graphite	Molybdenum	Tungsten	MoSi ₂
Material of insulation	Graphite felt	Molybdenum	Tungsten/Molybdenum	Ceramic fiber

¹Tmax reduces to 1400 °C

²Depending on Tmax

³Only with safety package for flammable gases

⁴Up to 1800 °C

Model	Inner dimensions of process box in mm			Volume in l
	w	d	h	
VHT 8/..	120	210	150	3,5
VHT 40/..	250	430	250	25,0
VHT 70/..	325	475	325	50,0
VHT 100/..	425	500	425	90,0
VHT 250/..	575	700	575	230,0
VHT 500/..	725	850	725	445,0



Front made of textured stainless steel

Model	Inner dimensions in mm			Volume in l	Max. charge weight/kg	Outer dimensions in mm			Heating power in kW ⁴			
	w	d	h			W	D	H	Graphite	Molybdenum	Tungsten	Ceramic fiber
VHT 8/..	170	240	200	8	5	1250 (800) ¹	1100	2000	27	19/34 ³	50	12
VHT 40/..	300	450	300	40	30	1600	2100	2300	83/103 ²	54/60 ³	130	30
VHT 70/..	375	500	375	70	50	1700	2500	2400	105/125 ²	70/100 ³	150	55
VHT 100/..	450	550	450	100	75	1900	2600	2500	131/155 ²	90/140 ³	on request	85
VHT 250/..	600	750	600	250	175	3000 ¹	4300	3100	180/210 ²	on request	on request	on request
VHT 500/..	750	900	750	500	350	3200 ¹	4500	3300	220/260 ²	on request	on request	on request

¹With separated switching system unit

²1800 °C/2200 °C

³1200 °C/1600 °C

⁴Depending on furnace design connected load might be higher

Cold-Wall Retort Furnaces up to 2400 °C or up to 3000 °C



Retort furnace SVHT 9/24-W with tungsten heating

Compared with the VHT models (page 16 ff), the retort furnaces of the SVHT product line offer improved performance data with regard to achievable vacuum and maximum temperature. Due to the design as pit-type furnace with tungsten heating, processes up to max. 2400 °C even in high vacuum can be implemented with retort furnaces of the SVHT..-W product line. Retort furnaces of the SVHT..-GR product line with graphite heating, also in pit-type design, can be operated in an inert gas atmosphere even up to max. 3000 °C.

- Standard sizes with a furnace chamber of 2 or 9 liters
- Designed as pit-type furnace, charged from above
- Frame construction with inserted sheets of textured stainless steel
- Dual shell water-cooled stainless steel container
- Manual operation of process gas and vacuum functions
- Manual gas supply for non-combustible process gas
- A step in front of the retort furnace for an ergonomic charging height
- Retort lid with gas-charged shock absorbers
- Controls and switchgear as well as gas supply integrated in furnace housing
- Defined application within the constraints of the operating instructions



Graphite heating module

- NTLog Basic for Nabertherm controller: recording of process data with USB-flash drive
- Further standard product characteristics see description for standard design of VHT models page 16

Heating Options

SVHT ..-GR

- Applicable for processes:
 - Under protective or reaction gases or in the vacuum up to 2200 °C under consideration of relevant max. temperature limits
 - Under inert gas argon up to 3000 °C
- Max. vacuum up to 10⁻⁴ mbar depending on the type of pump used
- Heating: graphite heating elements in cylindrical arrangement
- Insulation: graphite felt insulation
- Temperature measurement by means of an optical pyrometer



Cylindrical retort with tungsten heating

SVHT ..-W

- Applicable for processes under protective or reaction gases or in vacuum up to 2400 °C
- Max. vacuum up to 10⁻⁵ mbar depending on the type of pump used
- Heating: cylindrical tungsten heating module
- Insulation: tungsten and molybdenum radiant plates
- Temperature measurement with thermocouple type C



Cooling water distribution

Additional equipment such as automatic process gas control or design for the operation with flammable gases incl. safety system see VHT models page 16.

Model	Tmax °C	Work space dimensions Ø x h in mm	Useful volume in l	Outer dimensions in mm			Heating power in KW ¹	Electrical connection*
				W	D	H		
SVHT 2/24-W	2400	150 x 150	2,5	1300	2500	2000	55	3-phase
SVHT 9/24-W	2400	230 x 230	9,5	1400	2900	2100	95	3-phase
SVHT 2/30-GR	3000	150 x 150	2,5	1400	2500	2100	65	3-phase
SVHT 9/30-GR	3000	230 x 230	9,5	1500	2900	2100	115	3-phase

¹Depending on furnace design connected load might be higher

*Please see page 81 for more information about supply voltage

Bottom Loading Retort Furnace up to 2400 °C



Retort furnace LBVHT 250/20-W with tungsten heating chamber

The LBVHT model series with bottom loading specification are especially suitable for production processes which require either protective or reaction gase atmosphere or a vacuum. The basic performance specifications of these models are similar to the VHT models. Their size and design with electro-hydraulically driven table facilitate charging during production. The retort furnaces are available in various sizes and designs. Similar like the VHT models, these furnaces can be equipped with different heating concepts.

- Standard furnace sizes between 100 and 600 liters
- Designed as bottom loading retort furnace with electro-hydraulically driven table for easy and well-arranged charging
- Prepared to carry heavy charge weights
- Different heating concepts using
 - Graphite heating chamber up to Tmax 2400 °C
 - Molybdenum heating chamber up to Tmax 1600 °C
 - Tungsten heating chamber up to Tmax 2000 °C
- Frame structure filled with textured stainless steel sheets
- Standard design with gassing system for non-flammable protective or reaction gases
- Automatic gas supply system which also allows for operation with several process gases as additional equipment
- Gas supply systems for operating with hydrogen or other combustible reaction gases incl. safety package as additional equipment
- Switchgear and control box as well as gassing system integrated into the furnace housing
- Further product characteristics of the standard furnace as well as possible additional equipment can be found in the description of the VHT furnaces from Page 16

Model	Tmax °C	Model	Tmax °C	Model	Tmax °C	Inner dimensions in mm		Volume in l	Electrical connection*
						Ø	h		
LBVHT 100/16-MO	1600	LBVHT 100/20-W	2000	LBVHT 100/24-GR	2400	450	700	100	3-phase
LBVHT 250/16-MO	1600	LBVHT 250/20-W	2000	LBVHT 250/24-GR	2400	600	900	250	3-phase
LBVHT 600/16-MO	1600	LBVHT 600/20-W	2000	LBVHT 600/24-GR	2400	800	1200	600	3-phase

*Please see page 81 for more information about supply voltage



Retort furnace LBVHT 600/24-GR



Retort furnace LBVHT with graphite heating chamber

Retort Furnaces for Catalytic Debinding also as Combi Furnaces for Catalytic or Thermal Debinding



Retort furnace NRA 40/02 with cupboard for the acid pump

The retort furnaces NRA 40/02 CDB and NRA 150/02 CDB are specially developed for catalytic debinding of ceramics and metallic powder injection molded parts. They are equipped with a gastight retort with inside heating and gas circulation. During catalytic debinding, the polyacetal-containing (POM) binder chemically decomposes in the oven under nitric acid and is carried out of the oven by a nitrogen carrier gas and burned in an exhaust gas torch. Both retort furnaces have a comprehensive safety package to protect the operator and the surrounding.

Executed as combi furnace series CTDB these retort furnace can be used for either catalytic or thermal debinding incl. presintering if necessary and possible. The presintered parts can be easily transferred into the sintering furnace. The sintering furnace remains clean as no residual binder can exhaust anymore.

- Process retort made of acid-resistant stainless steel 1.4571 with large swiveling door
- Four-side heating inside the retort through chromium steel tube heating elements for good temperature uniformity
- Horizontal gas circulation for uniform distribution of the process atmosphere
- Acid pump and acid vessel (to be provided by the customer) accommodated in the furnace frame
- Gas-fired exhaust gas torch with flame monitoring
- Extensive safety package with redundantly operating safety PLC for safe operation with nitric acid



Acid pump for nitric acid

- Large, graphic process control H3700 for entering data and for process visualization
- Emergency tank for flushing in case of a failure
- Defined application within the constraints of the operating instructions

Version NRA .. CDB

- Tmax 200 °C
- Automatic gas supply system for nitrogen with mass flow controller
- Adjustable acid volume and correspondingly adjusted gas supply volumes

Version NRS .. CTDB

- Available for 600 °C and 900 °C with atmosphere circulation

Additional equipment

- Scale for the nitric acid vessel, connected to the PLC monitors the acid consumption and visualizes the fill level of the acid vessel (NRA 150/02 CDB)
- Lift truck for easy loading of the furnace
- Cupboard for acid pump
- Process control and documentation via Nabertherm Control Center (NCC) for monitoring, documentation and control see page 80



Retort with internal heating and process chamber

Model	Tmax °C	Inner dimensions in mm			Volume in l	Outer dimensions in mm			Heating power in kW ²	Electrical connection*	Weight in kg	Acidic quantity (HNO ₃)	Nitrogen (N ₂)
		w	d	h		W	D	H					
NRA 40/02 CDB	200	300	450	300	40	1400	1600	2400	2,0	3-phase ¹	800	max. 70 ml/h	1000 l/h
NRA 150/02 CDB	200	450	700	450	150	1650	1960	2850	20,0	3-phase ¹	1650	max. 180 ml/h	max. 4000 l/h

¹Heating only between two phases

²Depending on furnace design connected load might be higher

*Please see page 81 for more information about supply voltage

Clean Room Solutions

Clean room applications impose particularly high requirements to the design of the chosen furnace. If the complete furnace is operated in a clean room an essential contamination of the clean room atmosphere must be avoided. Especially, the particle contamination must be reduced to a minimum.

The specific application determines the choice of the required furnace technology. In many cases forced convection furnaces are required to achieve the necessary temperature uniformity at lower temperatures. For higher temperatures, Nabertherm has also delivered many furnaces with radiant heating.

Furnace Installation in the Clean Room

If the complete furnace is supposed to be positioned in the clean room, then it is important that both the furnace chamber and the furnace housing as well as the controls provide for good protection against contamination. Surfaces must be easy to clean. The furnace chamber is tightly sealed to the insulation behind it. If necessary, additional equipment such as filters for the fresh air supply or the air circulation in the furnace can be used to improve the cleanliness class. It is recommended to install the switchgear and the furnace controls outside the clean room.



KTR 8000 designed as a production oven in the clean room with filters for air circulation

Furnace Installation in the Grey Room, Furnace Charging from the Clean Room

Optimal results with respect to cleanness will be achieved by placing the furnace in the grey room with charging from the clean room. This significantly reduces the amount of costly space needed in the clean room to a minimum. The front and the furnace interior in the clean room are designed for easy cleaning. With this configuration even the highest clean room classes can be achieved.

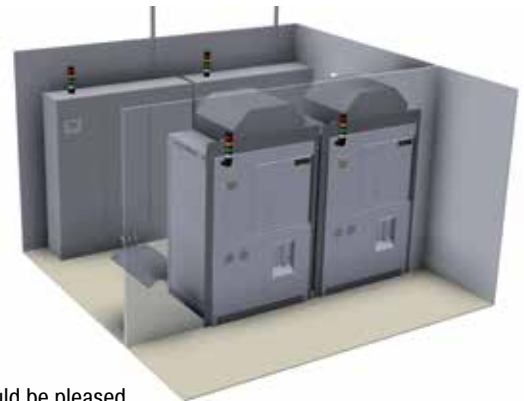

High-temperature furnace with loading from the clean room; switchgear and furnace installed in grey room

Sluice Furnace between Grey Room and Clean Room

Logistics between clean room and grey room can often be easily sorted out. Lock furnaces with one door in the grey room and the other door in the clean room are the perfect choice for these applications. The inner chamber as well as the furnace front in the clean room will be especially designed for lowest particle contamination.

Please contact us if you are looking for a heat treatment solution under clean room conditions. We would be pleased to quote for the oven or furnace model that meets best your requirements.



Hot-wall retort furnace NRA 1700/06 with charging frame for installation in grey room with charging door in clean room



Forced convection chamber oven NAC 250/45 with clean room specs

Forced Convection Chamber Furnaces < 675 Liters Electrically Heated



Forced convection chamber furnace
NA 120/45



Forced convection chamber furnace NA 250/45



Forced convection chamber furnace
N 15/65HA as table-top model

The very good temperature uniformity of these chamber furnace with air circulation provides for ideal process conditions for annealing, curing, solution annealing, artificial ageing, preheating, or soft annealing and brazing. The forced convection chamber furnaces are equipped with a suitable annealing box for soft annealing of copper or tempering of titanium, and also for annealing of steel under non-flammable protective or reaction gases. The modular forced convection chamber furnace design allows for adaptation to specific process requirements with appropriate

accessories.

- Tmax 450 °C, 650 °C, or 850 °C
- Stainless steel air-baffles in the furnace for optimum air circulation
- Swing door hinged on the right side
- Base frame included in the delivery, N 15/65 HA designed as table-top model
- Horizontal air circulation
- Temperature uniformity up to +/- 4 °C according to DIN 17052-1 (model N 15/65 HA up to +/- 7 °C) see page 76
- Optimum air distribution enabled by high flow speeds
- One frame sheet and rails for two additional trays included in the scope of delivery (N 15/65 HA without frame sheet)
- Defined application within the constraints of the operating instructions
- NTLog Basic for Nabertherm controller: recording of process data with USB-flash drive
- Controls description see page 80

Additional equipment (not for model N 15/65HA)

- Optimization of the temperature uniformity up to +/- 3 °C according to DIN 17052-1 see page 76
- Air inlet and exhaust air flaps when used for drying
- Controlled cooling with fan
- Manual lift door (up to model N(A) 120/.. (HA))
- Pneumatic lift door
- air circulation with speed control, recommendable for processes with light or sensitive charge
- Additional frame sheet
- Roller conveyor in furnace chamber for heavy charges



Roller conveyor in forced convection
chamber furnace N 250/85HA



Forced convection chamber furnace
NA 500/65



Forced convection chamber furnace
N 250/85HA with quenching bath

- Annealing boxes see page 58
- Feed and charging aids see page 56
- Safety technology according to EN 1539 (NFPA 86) (models NA .. LS) for charges containing solvents see page 38
- Inlets, measuring frames and thermocouples for TUS measurements charge or comparative measurements
- Charge control
- Process control and documentation via VCD software package or Nabertherm Control Center (NCC) for monitoring, documentation and control see page 80



Forced convection chamber furnace
NA 500/S with four compartments, each
with roller conveyor and individual door

Model	Tmax °C	Inner dimensions in mm			Volume in l	Outer dimensions in mm			Heating power in kW ³ NA/NA .. LS	Electrical connection*	Weight in kg
		w	d	h		W	D	H			
NA 30/45(LS)	450	290	420	260	30	1040	1290	1385	3.0 / 9.0	1(3)-phase	285
NA 60/45(LS)	450	350	500	350	60	1100	1370	1475	6.0 / 12.0	3-phase	350
NA 120/45(LS)	450	450	600	450	120	1250	1550	1550	9.0 / 18.0	3-phase	460
NA 250/45(LS)	450	600	750	600	250	1350	1650	1725	12.0 / 24.0	3-phase	590
NA 500/45(LS)	450	750	1000	750	500	1550	1900	1820	18.0 / 24.0	3-phase	750
NA 675/45(LS)	450	750	1200	750	675	1550	2100	1820	24.0 / 30.0	3-phase	900
N 15/65 HA ¹	650	295	340	170	15	470	845	460	2.4	1-phase	55
NA 30/65	650	290	420	260	30	870	1290	1385	5.0	3-phase ²	285
NA 60/65	650	350	500	350	60	910	1390	1475	9.0	3-phase	350
NA 120/65	650	450	600	450	120	990	1470	1550	12.0	3-phase	460
NA 250/65	650	600	750	600	250	1170	1650	1680	20.0	3-phase	590
NA 500/65	650	750	1000	750	500	1290	1890	1825	27.0	3-phase	750
NA 675/65	650	750	1200	750	675	1290	2100	1825	27.0	3-phase	900
N 30/85 HA	850	290	420	260	30	607 + 255	1175	1315	5.5	3-phase ²	195
N 60/85 HA	850	350	500	350	60	667 + 255	1250	1400	9.0	3-phase	240
N 120/85 HA	850	450	600	450	120	767 + 255	1350	1500	13.0	3-phase	310
N 250/85 HA	850	600	750	600	250	1002 + 255	1636	1860	20.0	3-phase	610
N 500/85 HA	850	750	1000	750	500	1152 + 255	1886	2010	30.0	3-phase	1030
N 675/85 HA	850	750	1200	750	675	1152 + 255	2100	2010	30.0	3-phase	1350

¹Table-top model see page 24

²Heating only between two phases

³Please see page 81 for more information about supply voltage

³Depending on furnace design connected load might be higher

Forced Convection Chamber Furnaces > 1000 Liters Electrically Heated or Gas-Fired



Forced convection chamber furnace
N 3920/26HAS



Enclosed heater coils on electrically
heated models



Compact burners for standard models up
to NB 600



Forced convection chamber furnace
N 1500/85HA with electric charging system for
heavy loads

These forced convection chamber furnaces are available for maximum operating temperatures of 260 °C, 450 °C, 600 °C or 850 °C and are perfectly suited for demanding processes. Due to their robust and solid design even heavy loads can be heat treated. These furnaces are suited for use with baskets, pallets, and mobile furnace racks. The charging can be carried out with fork lift, pallet truck, or charging trolley. The basic forced convection chamber furnaces are standing on the shop floor without bottom insulation. Charging can be simplified by roller conveyors, if necessary also motorized. All furnaces are available with electric heated or gas heating.

Standard version for models up to 600 °C (850 °C models see page 30)

- Tmax 260 °C, 450 °C or 600 °C
- Electrically heated or gas-fired
- Electric heating by means of heater coils
- Direct gas heating or upon request with indirect gas heating with radiation tube, e.g. for heat treatment of aluminum
- Optimal air circulation for your charge by means of adjustable air outlets
- Horizontal air circulation (type ../HA)
- High air exchange for perfect heat transfer
- Ground level charging without bottom insulation for 260 °C models
- Temperature uniformity up to +/- 5 °C according to DIN 17052-1 see page 76
- Furnace chamber lined with alloy 1.4301 (DIN)
- High quality mineral wool insulation provides for low outer temperatures
- Inside unlocking device for furnaces with walk-in work space
- Furnace sizes suitable for common charging systems, such as pallets, baskets, etc.
- Double-wing door for furnaces with an internal width of more than 1500 mm (260 °C and 450 °C models). Furnaces for higher temperatures and with smaller sizes are equipped with a single-wing door.
- Over-temperature limiter with adjustable cutout temperature for thermal protection class 2 in accordance with EN 60519-2 as temperature limiter to protect the furnace and load



Forced convection chamber furnace N 2520/60HA with roller conveyor inside and in front of the furnace



Forced convection chamber furnace N 1500/85HA with lift door and work piece holders in the furnace

- Defined application within the constraints of the operating instructions
- NTLog Basic for Nabertherm controller: recording of process data with USB-flash drive
- Controls description see page 80

Additional equipment for models up to 600 °C

- Optional floor insulation provides for improved temperature uniformity for 260 °C models
- Entry ramps or track cutouts for floor-level charging cart of models with bottom insulation (not for 600 °C models)
- Furnace positioned on base frame provides for ergonomic charging height
- Electro-hydraulic lift door
- Fan system for faster cooling with manual or motor-driven control
- Motor-driven control of air inlet and exhaust air flaps for better ventilation of the furnace chamber
- Observation window and/or furnace chamber lighting (not for 600 °C models)
- Optimization of the temperature uniformity up to +/- 3 °C according to DIN 17052-1 see page 76
- Safety technology according to EN 1539 for charges containing solvents (not for 600 °C models) see page 38
- Charging systems or roller conveyors, also electrically driven provide for easy charging see page 56
- Catalytic or thermal exhaust gas cleaning systems
- Process control and documentation via VCD software package or Nabertherm Control Center (NCC) for monitoring, documentation and control see page 80



Pull-out drawers for heavy loads



Track cutouts for pallet truck or charging cart

Forced Convection Chamber Furnaces

Electrically Heated or Gas-Fired



Forced convection chamber furnace N 140000/26AS for curing of composites in vacuum bags incl. pump and necessary connections in the furnace chamber



Forced Convection Chamber Furnaces > 560 Liters Electrically Heated or Gas-Fired



N 12000/25HA



N 24500/20HAS



Forced convection furnace N 790/65HAS, adjustable in height, for integration in a heat treatment plant

Standard version for models 850 °C

- Tmax 850 °C
- Electrically heated or gas-fired
- Electric heating with heating elements on supports tubes
- Direct gas heating into the outlet of the air circulation fan
- Optimal air circulation for your charge by means of adjustable air outlets
- Horizontal air circulation (type ../HA)
- High air exchange provides for perfect heat transfer
- Base frame with 900 mm charging height
- Temperature uniformity up to +/- 5 °C according to DIN 17052-1 see page 76
- Air baffles made of 1.4828 (DIN)
- Multi-layer insulation with fiber plates (not classified according to EU directive 67/548) provides for low outer temperatures
- Furnaces sizes perfectly suited to accommodate common charging systems, e.g. like pallets or pallet boxes
- Over-temperature limiter with adjustable cutout temperature for thermal protection class 2 in accordance with EN 60519-2 as temperature limiter to protect the furnace and load
- Defined application within the constraints of the operating instructions
- Controls description see page 80

Additional equipment for models 850 °C

- Electro-hydraulic lift door
- Fan system for faster cooling with manual or motor-driven control
- Motor-driven air inlet and control of exhaust air flaps for better ventilation of the furnace chamber
- Optimization of the temperature uniformity up to +/- 3 °C according to DIN 17052-1 see page 76
- Base frame for customized charging height
- Charging systems or roller conveyors, also electrically driven provide for easy charging see page 56
- Designed for Tmax 950 °C
- Process control and documentation via VCD software package or Nabertherm Control Center (NCC) for monitoring, documentation and control see page 80



N 670/65HAS with quenching tank

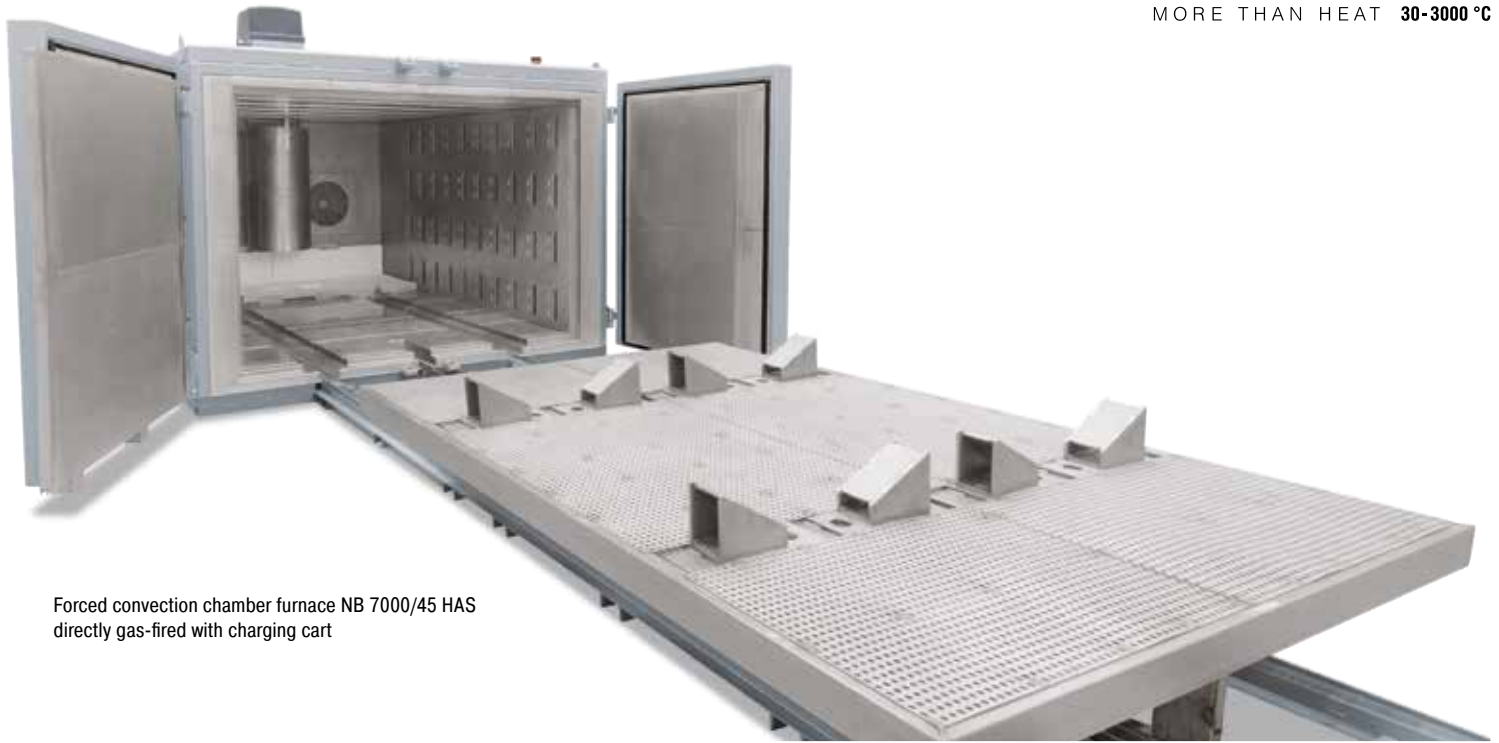

Forced convection chamber furnace NB 7000/45 HAS directly gas-fired with charging cart

Model	Tmax °C	Inner dimensions in mm			Volume in l	Outer dimensions in mm			Circulation rate m³/h	Heating power in kW²	Electrical connection*
		w	d	h		W	D	H			
N 1000/26HA	260	1000	1000	1000	1000	1930	1900	1600	3600	15	3-phase
N 1500/26HA	260	1500	1000	1000	1500	2380	1900	1600	3600	18	3-phase
N 1500/26HA1	260	1000	1500	1000	1500	1880	2400	1600	3600	18	3-phase
N 2000/26HA	260	1500	1100	1200	2000	2380	2000	1800	6400	18	3-phase
N 2000/26HA1	260	1100	1500	1200	2000	1980	2400	1800	6400	18	3-phase
N 2010/26HA	260	1000	1000	2000	2000	1880	1900	2720	7200	24	3-phase
N 2880/26HA	260	1200	1200	2000	2880	2080	2100	2720	7200	48	3-phase
N 4000/26HA	260	1500	2200	1200	4000	2380	3110	1800	9000	42	3-phase
N 4000/26HA1	260	2200	1500	1200	4000	3080	2410	1800	9000	42	3-phase
N 4010/26HA	260	1000	2000	2000	4000	1880	2900	2720	12800	48	3-phase
N 4010/26HA1	260	2000	1000	2000	4000	2880	1900	2720	12800	48	3-phase
N 4500/26HA	260	1500	1500	2000	4500	2380	2400	2720	12800	48	3-phase
N 5600/26HA	260	1500	2500	1500	5600	2110	3180	2340	18000	60	3-phase
N 6750/26HA	260	1500	3000	1500	6750	2110	3680	2340	19200	90	3-phase
N 7200/26HA	260	2000	1500	2400	7200	2610	2410	3000	18000	84	3-phase
N 10000/26HA	260	2000	2500	2000	10000	2610	3180	2840	25600	96	3-phase
N 1000/45HA(E¹)	450	1000	1000	1000	1000	1930	1900	1600	3600	15' / 36	3-phase
N 1500/45HA(E¹)	450	1500	1000	1000	1500	2380	1900	1600	3600	18' / 36	3-phase
N 1500/45HA1(E¹)	450	1000	1500	1000	1500	1880	2400	1600	3600	18' / 36	3-phase
N 2000/45HA(E¹)	450	1500	1100	1200	2000	2380	2000	1800	6400	18' / 42	3-phase
N 2000/45HA1(E¹)	450	1100	1500	1200	2000	1980	2400	1800	6400	18' / 42	3-phase
N 2010/45HA(E¹)	450	1000	1000	2000	2000	1880	1900	2720	7200	24' / 48	3-phase
N 2880/45HA(E¹)	450	1200	1200	2000	2880	2080	2100	2720	7200	48' / 60	3-phase
N 4000/45HA(E¹)	450	1500	2200	1200	4000	2380	3110	1800	9000	42' / 60	3-phase
N 4000/45HA1(E¹)	450	2200	1500	1200	4000	3080	2410	1800	9000	42' / 60	3-phase
N 4010/45HA(E¹)	450	1000	2000	2000	4000	1880	2900	2720	12800	48' / 60	3-phase
N 4010/45HA1(E¹)	450	2000	1000	2000	4000	2880	1900	2720	12800	48' / 60	3-phase
N 4500/45HA(E¹)	450	1500	1500	2000	4500	2380	2400	2720	12800	48' / 60	3-phase
N 5600/45HA(E¹)	450	1500	2500	1500	5600	2110	3180	2340	18000	60' / 84	3-phase
N 6750/45HA(E¹)	450	1500	3000	1500	6750	2110	3680	2340	19200	90' / 108	3-phase
N 7200/45HA(E¹)	450	2000	1500	2400	7200	2610	2410	3000	18000	84' / 108	3-phase
N 10000/45HA(E¹)	450	2000	2500	2000	10000	2610	3180	2840	25600	96' / 120	3-phase
N 1000/60HA	600	1000	1000	1000	1000	1930	1900	1600	3600	36	3-phase
N 1500/60HA	600	1500	1000	1000	1500	2380	1900	1600	3600	36	3-phase
N 1500/60HA1	600	1000	1500	1000	1500	1930	2400	1600	3600	36	3-phase
N 2000/60HA	600	1500	1100	1200	2000	2380	2000	1800	6400	42	3-phase
N 2000/60HA1	600	1100	1500	1200	2000	1980	2400	1800	6400	42	3-phase
N 4000/60HA	600	1500	2200	1200	4000	2380	3110	1800	9000	60	3-phase
N 4000/60HA1	600	2200	1500	1200	4000	3080	2410	1800	9000	60	3-phase
N 1000/85HA	850	1000	1000	1000	1000	2100	2000	1900	3400	40	3-phase
N 1500/85HA	850	1500	1000	1000	1500	2600	2000	1900	6400	40	3-phase
N 1500/85HA1	850	1000	1500	1000	1500	2100	2600	1900	6400	40	3-phase
N 2000/85HA	850	1500	1100	1200	2000	2600	2100	2100	9000	60	3-phase
N 2000/85HA1	850	1100	1500	1200	2000	2200	2800	2100	9000	60	3-phase
N 4000/85HA	850	1500	2200	1200	4000	2600	3400	2100	12600	90	3-phase



Drive-in ramps at furnaces with bottom insulation for processes which require a good temperature uniformity



Forced convection furnace N 4010/45HA with track cutouts, chamber lighting and observation window

¹Reduced connected power for plastics applications

*Please see page 81 for more information about supply voltage

²Depending on furnace design connected load might be higher

Chamber Ovens

Electrically Heated or Gas-Fired



Chamber oven KTR 1500



Chamber oven KTR 4500



Chamber oven KTR 6125

The chamber ovens of the KTR range can be used for complex drying processes and heat treatment of charges to an application temperature of 260 °C. The high-performance air circulation enables optimum temperature uniformity throughout the work space. A wide range of accessories allow the chamber ovens to be modified to meet specific process requirements. The design for the heat treatment of flammable materials in conformance with EN 1539 (NFPA 86) is available for all sizes.

- Tmax 260 °C
- Electrically heated (via a heating register with integrated chrome steel heating elements) or gas-fired (direct or indirect gas-fired including injection of the hot air into the intake duct)

- Temperature uniformity up to ± 3 °C according to DIN 17052-1 (for design without track cutouts) see page 76
- High-quality mineral wool insulation provides for outer temperatures of < 25 °C above room temperature
- High air exchange for fast drying processes
- Double-wing door for furnaces KTR 3100 and larger



Chamber oven KTR 1500 with charging cart



Chamber oven KTR 22500/S with chamber lightning and drive-in tracks with insulated plugs which provide for an optimal temperature uniformity

- Over-temperature limiter with adjustable cutout temperature for thermal protection class 2 in accordance with EN 60519-2 as temperature limiter to protect the oven and load
- Incl. floor insulation
- Defined application within the constraints of the operating instructions
- NTLog Basic for Nabertherm controller: recording of process data with USB-flash drive
- Controls description see page 80

Additional equipment

- Track cutouts for level drive-in of charging cart
- Base frame to charge the oven via a charging forklift
- Additional Door in the back for charging from both sides or to use the oven as lock between two rooms
- Fan system for faster cooling with manual or motor-driven control of the exhaust flaps
- Programmed opening and closing of exhaust air flaps
- Air circulation with speed control, recommendable for processes with light or sensitive charge
- Observation window and furnace chamber lighting
- Safety technology according to EN 1539 (NFPA 86) (models KTR .. LS) for charges containing solvents see page 38
- Charging cart with or without rack system
- Design for clean room heat treatment processes see page 23
- Rotating systems for tempering processes
- Process control and documentation via VCD software package or Nabertherm Control Center (NCC) for monitoring, documentation and control see page 80



KTR 3100/S for curing of composites in vacuum bags incl. pump and necessary connections in the oven chamber



Direct gas-firing at a chamber dryer

Chamber Ovens

Electrically Heated or Gas-Fired



Charging cart with pull-out trays



KTR 4500 with platform cart, inner lightning and observation windows



Drive-in tracks with sealing shoes

Accessories

- Adjustable plate shutters to adapt the air guide to the charge and improve temperature uniformity
- Guide-in tracks and shelves
- Shelves with 2/3 extraction with evenly distributed load on the whole shelf surface
- Platform cart in combination with drive-in tracks
- Charging cart with rack system in combination with drive-in tracks
- Sealing shoes for ovens with drive-in tracks to improve temperature uniformity in the work space

All KTR-models are also available with Tmax 300 °C.



Pull-out shelves, running on rolls

Model	Tmax °C	Inner dimensions in mm			Volume in l	Outer dimensions in mm ²			Heating power in kW ¹ KTR/KTR ..LS	Electrical connection*
		w	d	h		W	D	H		
KTR 1000 (LS)	260	1000	1000	1000	1000	1900	1430	1815	18/on request	3-phase
KTR 1500 (LS)	260	1000	1000	1500	1500	1900	1430	2315	18/36	3-phase
KTR 3100 (LS)	260	1250	1250	2000	3100	2150	1680	2905	27/45	3-phase
KTR 4500 (LS)	260	1500	1500	2000	4500	2400	1930	2905	45/54	3-phase
KTR 6125 (LS)	260	1750	1750	2000	6125	2650	2200	3000	45/63	3-phase
KTR 6250 (LS)	260	1250	2500	2000	6250	2150	3360	3000	54/on request	3-phase
KTR 8000 (LS)	260	2000	2000	2000	8000	2900	2450	3000	54/81	3-phase
KTR 9000 (LS)	260	1500	3000	2000	9000	2400	3870	3000	72/on request	3-phase
KTR 12300 (LS)	260	1750	3500	2000	12300	2650	4400	3000	90/on request	3-phase
KTR 16000 (LS)	260	2000	4000	2000	16000	2900	4900	3000	108/on request	3-phase
KTR 21300 (LS)	260	2650	3550	2300	21300	3750	4300	3500	108/on request	3-phase
KTR22500 (LS)	260	2000	4500	2500	22500	2900	5400	3500	108/on request	3-phase

¹Depending on furnace design connected load might be higher

²Outer dimensions from chamber ovens KTR .. LS are different

*Please see page 81 for more information about supply voltage

Max. amount of silicone per charge at a fresh air amount of 120 l/min/kg_{silicone}

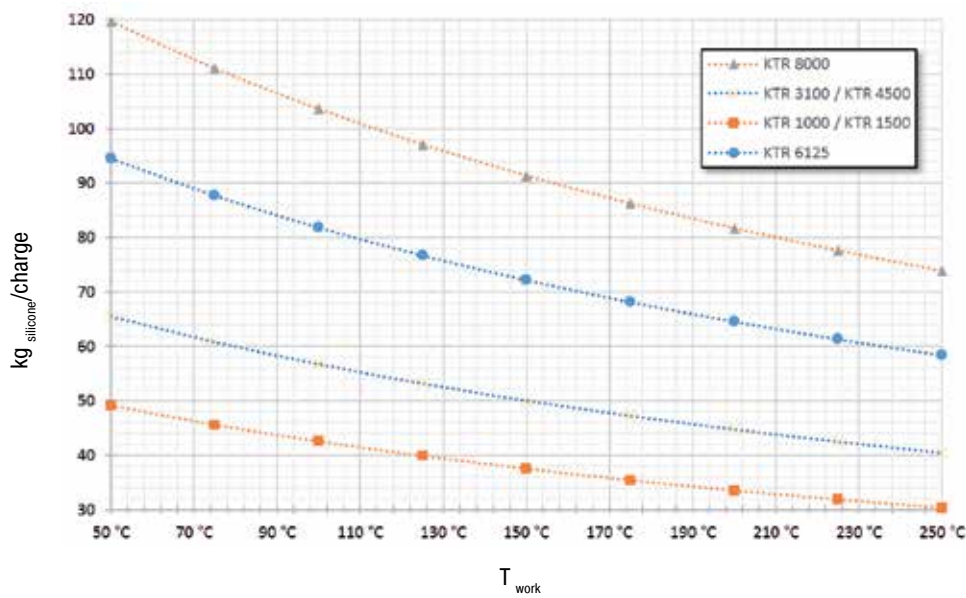

Adjustable plate shutters to adapt the air guide to the charge

To ensure safe operation of the oven when tempering silicone, the fresh air supply of the oven must be monitored. A fresh air volume flow of 100 - 120 l/min/kg silicone (6-7,2 m³/h/kg silicone) has to be considered. The graph shows the maximum amount of silicone depending on the operating temperature for various KTR models at a fresh air supply of 120 l/min/kg silicone. The oven will be carried out in accordance with the requirements of the standard EN 1539 (NFPA 86).



Motor-driven rotary rack with baskets for moving the charge during heat treatment



KTR 3100 DT with rotating system for tempering of silicone parts. Four baskets will be charged in the frame and can be taken out separately



Drive-in ramp

Ovens, also with Safety Technology According to EN 1539 Electrically Heated



Oven TR 60 with adjustable fan speed



Oven TR 240



Electrical rotating device as additional equipment see page 37



Extricable metal grids to load the oven in different layers

With their maximum working temperature of up to 300 °C and air circulation, the ovens achieve a perfect temperature uniformity which is much better than in ovens of most competitors. They can be used for various applications such as e.g. drying, sterilizing or warm storing. Ample warehousing of standard models provides for short delivery times.

- Tmax 300 °C
- Working temperature range: + 5 °C above room temperature up to 300 °C
- Ovens TR 60 - TR 240 designed as tabletop models
- Ovens TR 450 and TR 1050 designed as floor standing models
- Horizontal, air circulation results in temperature uniformity better than +/- 5 °C see page 76
- Stainless steel chamber, alloy 304 (AISI)/(DIN material no. 1.4301), rust-resistant and easy to clean
- Large handle to open and close the door
- Charging in multiple layers possible using removeable grids (number of removeable grids included, see table to the right)
- Large, wide-opening swing door, hinged on the right with quick release for models TR 60 - TR 450
- Double swing door with quick release for TR 1050
- TR 1050 equipped transport rollers
- Infinitely adjustable exhaust at the rear wall with operation from the front
- PID microprocessor control with self-diagnosis system
- Solid state relays provide for low-noise operation
- Defined application within the constraints of the operating instructions
- NTLLog Basic for Nabertherm controller: recording of process data with USB-flash drive
- Controls description see page 80



Oven TR 450



Oven TR 1050 with double door

Additional equipment

- Over-temperature limiter with adjustable cutout temperature for thermal protection class 2 in accordance with EN 60519-2 as temperature limiter to protect the oven and load
- Infinitely adjustable fan speed of the air circulation fan
- Window for charge observing
- Further removeable grids with rails
- Side inlet
- Stainless steel collecting pan to protect the furnace chamber
- Door hinges on the left side
- Reinforced bottom plate
- Safety Technology according to EN 1539 for charges containing liquid solvents (TR .. LS) up to model TR 240 LS, achievable temperature uniformity +/- 8 °C see page 76
- Transport costors for model TR 450
- Various modifications available for individual needs
- Upgrading available to meet the quality requirements of AMS 2750 E or FDA
- Process control and documentation via VCD software package for monitoring, documentation and control see page 80



Oven TR 60 with observation window and rotating device with selectable speed and door lock

Model	Tmax °C	Inner dimensions in mm			Volume in l	Outer dimensions in mm			Heating power in kW ²	Electrical connection*	Weight in kg	Grids in- cluded	Grids max.	Max. total load ¹
		w	d	h		W	D	H						
TR 60	300	450	390	350	60	700	610	710	3	1-phase	90	1	4	120
TR 60 LS	260	450	360	350	57	700	680	690	6	3-phase	92	1	4	120
TR 120	300	650	390	500	120	900	610	860	3	1-phase	120	2	7	150
TR 120 LS	260	650	360	500	117	900	680	840	6	3-phase	122	2	7	150
TR 240	300	750	550	600	240	1000	780	970	3	1-phase	165	2	8	150
TR 240 LS	260	750	530	600	235	1000	850	940	6	3-phase	167	2	8	150
TR 450	300	750	550	1100	450	1000	780	1470	6	3-phase	235	3	15	180
TR 1050	300	1200	670	1400	1050	1470	940	1920	9	3-phase	450	4	14	250

¹Max load per layer 30 kg

²Please see page 81 for more information about supply voltage

³Depending on furnace design connected load might be higher

Forced Convection Chamber Furnaces/Dryers with Safety Technology for Solvent-Containing Charges according to EN 1539 or NFPA 86



Ship-lock type furnace N 560/ 6HACLS with safety technology, front charging and rear unloading



Electrically heated chamber dryer KTR 1500 for drying of foundry cores with an alcohol-based binder



Exhaust port and powerful exhaust fan mounted on the furnace



Guide-in tracks for chamber dryers with bottom insulation

Safety Technology for Forced Convection Chamber Furnaces

Certain processes release and vaporize solvents or other flammable vapors. The concentration of these vapors must be kept below a certain limit to prevent ignition. European Norm EN 1539 and NFPA 86 in the USA prescribe the required safety equipment for these processes.

For these applications and processes, all forced convection furnaces of the KTR and forced convection chamber furnaces < 450 °C product lines are suited with safety technology for protection of a potential ignition in the furnace chamber.

To avoid an ignition in the furnace, flammable vapors must be diluted with air. Special care must be taken so high concentrations of flammable materials do not accumulate in "dead" areas within the furnace. For this purpose, the furnaces are equipped with an exhaust gas fan providing for a defined underpressure. A measurement system monitors this flow, while fresh air is simultaneously resupplied. In parallel, the furnace atmosphere is diluted by the inflow of fresh air. The air circulation is also monitored by the measurement system.

- Furnace sizes between 120 and 10,000 liters
- Powerful exhaust fan capable of maintaining underpressure in the furnace
- Defined and monitored air circulation flow and exhaust air
- Visual and audible emergency signals
- Over-temperature limiter with adjustable cutout temperature for thermal protection class 2 in accordance with EN 60519-2 as temperature limiter to protect the furnace and load

Forced Convection Pit-Type Furnaces Electrically Heated

Forced convection pit-type furnaces offer the advantage of easy charging, for heat treatment of heavy parts or loads in charge baskets. With maximum application temperatures available from 450 °C to 850 °C, these compact pit-type furnaces are particularly useful for processes such as tempering, solution annealing, artificial ageing, and soft annealing.

- Tmax 450 °C, 650 °C, 850 °C
- Air circulation fans in the furnace bottom, high circulation rate
- Vertical air circulation with square air heating chamber
- Temperature uniformity up to +/- 4 °C according to DIN 17052-1 see page 76
- Interior walls from stainless steel
- Switchgear with solid-state relays
- Defined application within the constraints of the operating instructions
- NTLog Basic for Nabertherm controller: recording of process data with USB-flash drive
- Controls description see page 80

Additional equipment

- Charging hoist with swivel arm and charge basket
- Optimization of the temperature uniformity up to +/- 2 °C according to DIN 17052-1 see page 76
- Integrated fan for rapid cool down or separate cooling station for annealing box cooling outside of the furnace
- Annealing box with protective gas inlet and outlet for production in a defined atmosphere see page 58
- Manual or automatic gas supply systems for non-flammable protective or reaction gases see page 58
- Process control and documentation via VCD software package for monitoring, documentation and control see page 80



Pit-type furnace
SAL 250/65



Pit-type furnace SAL 120/65 with protective gas retort box and cooling station next to the furnace



Basket system for charging in different layers

Model	Tmax °C	Inner dimensions in mm			Volume in l	Max. charging weight in kg	Outer dimensions in mm			Heating power in kW ²	Electrical connection*	Weight in kg
		w	d	h			W	D	H			
SAL 30/45	450	300	250	400	30	120	750	850	1250	3.0	1-phase	130
SAL 60/45	450	350	350	500	60	120	800	950	1350	6.0	3-phase	225
SAL 120/45	450	450	450	600	120	120	900	1050	1450	9.0	3-phase	280
SAL 250/45	450	600	600	750	250	400	1050	1200	1600	18.0	3-phase	750
SAL 500/45	450	750	750	900	500	400	1200	1350	1750	27.0	3-phase	980
SAL 30/65	650	300	250	400	30	120	750	850	1250	5.5	3-phase ¹	130
SAL 60/65	650	350	350	500	60	120	800	950	1350	9.0	3-phase	225
SAL 120/65	650	450	450	600	120	120	900	1050	1450	13.0	3-phase	280
SAL 250/65	650	600	600	750	250	400	1050	1200	1600	20.0	3-phase	750
SAL 500/65	650	750	750	900	500	400	1200	1350	1750	30.0	3-phase	980
SAL 30/85	850	300	250	400	30	80	600	740	1000	5.5	3-phase ¹	130
SAL 60/85	850	350	350	500	60	80	800	950	1350	9.0	3-phase	225
SAL 120/85	850	450	450	600	120	80	900	1050	1450	13.0	3-phase	280
SAL 250/85	850	600	600	750	250	250	1050	1200	1600	20.0	3-phase	750
SAL 500/85	850	750	750	900	500	250	1200	1350	1750	30.0	3-phase	980

¹Heating only between two phases

²Depending on furnace design connected load might be higher

*Please see page 81 for more information about supply voltage



Pit-type furnace SAL 30/65 with exchangeable retort and two retort air cooling devices

Forced Convection Pit-Type Furnaces

Electrically Heated or Gas-Fired



Forced Convection Pit-Type Furnace
SAH 1780/60S



Motor-driven fresh-air and exhaust air flaps



Forced convection pit-type furnaces
S 10400/75 AS in production



Forced convection pit-type furnaces
SAH 5600/75 S in production



Forced Convection Pit-Type Furnace
SAH 1700/60S with rolling lid

Due to their robust design, these pit-type furnaces with air circulation are particularly useful for a professional heat treatment demanding optimum temperature uniformity. Production processes such as tempering, solution annealing, artificial ageing, and soft annealing can be realized with these pit-type furnaces.

- Tmax 600 °C or 850 °C
- Useful for heavy charge weights
- Air circulation fans in the furnace lid, high circulation rate

- Heating chamber with air baffle cylinder
- Heating elements on all wall surfaces
- Distribution of air flow through grid at the furnace bottom
- Pneumatic or hydraulic lid lifting device
- Temperature uniformity up to +/- 3 °C according to DIN 17052-1 see page 76
- Defined application within the constraints of the operating instructions
- NTLog Basic for Nabertherm controller: recording of process data with USB-flash drive
- Controls description see page 80

Additional equipment

- Integral fan for fast cooling
- Optimization of the temperature uniformity up to +/- 2 °C according to DIN 17052-1 see page 76
- Variable rpm converter control of the air circulation velocity for sensitive parts
- Multiple zone control or special air circulation system for optimum temperature uniformity tailored to the charge
- Charge weights up to 7 tons
- Process control and documentation via VCD software package or Nabertherm Control Center (NCC) for monitoring, documentation and control see page 80

Model	Tmax °C	Inner dimensions cond. cylinder		Volume in l	Max. charging weight in kg	Outer dimensions in mm			Heating power in kW ¹	Electrical connection*
		ø in mm	h in mm			W	D	H		
SAH 200/..	600 or 850	600	800	200	400	1460	1460	1850	27	3-phase
SAH 300/..		600	1000	300	400	1460	1460	2050	27	3-phase
SAH 500/..		800	1000	500	600	1660	1660	2050	36	3-phase
SAH 600/..		800	1200	600	600	1660	1660	2250	54	3-phase
SAH 800/..		1000	1000	800	1000	2000	2000	2050	63	3-phase
SAH 1000/..		1000	1300	1000	1000	2000	2000	2400	81	3-phase
SAH 1280/..		800	1600	1300	800	1660	1660	2800	81	3-phase
SAH 5600/..		1800	2200	5600	5000	2700	3000	3900	120	3-phase

¹Depending on furnace design connected load might be higher

*Please see page 81 for more information about supply voltage

Pit-Type and Top-Loading Furnaces with or without Air Circulation Electrically Heated or Gas-Fired

Our top-loading furnaces are perfectly suited for the heat treatment of longer or heavier components. The furnace is usually charged with a factory crane. Due to their high-performance air circulation, the furnaces provide for excellent temperature uniformity up to a maximum temperature of 850 °C. The top-loading furnaces for the temperature range up to 1280 °C provide for very good temperature uniformity due to their five-side heating. Alternatively, these furnaces can also be provided with gas heating. Customized dimensions are designed and produced to accommodate the size and weight of the components to be treated.



Top-loading furnace S 5120/GS1, furnace chamber divided in two sections, split cover

- Tmax 260 °C, 450 °C, 600 °C or 850 °C for furnaces with air circulation
- Tmax 900 °C or 1280 °C for furnaces with radiation heating
- Electrically heated or gas-fired
- Heating from both long sides for furnaces with air circulation
- Heating from all four sides and the bottom with SiC plates in the bottom as level stacking support for models to 900 °C or 1280 °C
- High-quality insulation, adapted to the specific maximum temperature
- Electrohydraulic opening system of the lid with two-hand operation
- Closable air supply vents in the lower area of the furnace chamber
- Closable exhaust air flaps in the lid
- Over-temperature limiter with adjustable cutout temperature for thermal protection class 2 in accordance with EN 60519-2 as temperature limiter to protect the furnace and load
- Defined application within the constraints of the operating instructions



Furnace chamber S 5120/GS with receptacle for an insulating plate in order to divide the furnace chamber

Additional equipment

- Motor-driven exhaust air flaps for faster cooling
- Controlled fan cooling with motor-driven exhaust air flaps
- Multi-zone control of the heating provides for optimum temperature uniformity
- Furnace chamber can be divided in length for short workparts, partitions can be controlled separately
- Designed for Tmax 950 °C, fan blade driven indirectly via a belt to protect the air recirculation motor against over-heating
- Process control and documentation via VCD software package or Nabertherm Control Center (NCC) for monitoring, documentation and control see page 80



Charge supports for long tubes in a top-loading forced convection furnace SAL 750/08



Top-loading furnace SAT 1512/85S



Pit-type furnace S 11988/S with rolling lid

Forced Convection Bogie Hearth Furnaces

Electrically Heated or Gas-Fired



Directly gas-fired bogie hearth furnace WB 4500/85A

Forced convection bogie hearth furnace W 5290/85 AS with annealing box for heat treatment of coils under protective gas

The forced convection bogie hearth furnaces W 1000/60A - W 8300/85A are used when heavy charges weighing up to more than 25 t have to be heat-treated. They are ideal for processes such as solution annealing, artificial ageing, annealing or soft annealing, for which a high degree of temperature uniformity is crucial. The high-performance air circulation assures that the temperature uniformity achieved throughout the work space is outstanding. A broad selection of additional equipment enables these bogie hearth furnaces to be optimally adapted to suit specific processes.



Cooling fan for accelerated cooling

- Tmax 600 °C or 850 °C
- Dual shell housing with rear ventilation provides for low shell temperatures for the 850 °C models
- Swing door hinged on the right side
- Heating from chrome steel heating elements for the 600 °C models
- Heating from three sides (both side walls and the trolley) for the 850 °C models
- High-performance air circulation fan with vertical circulation
- Temperature uniformity up to +/- 5 °C according to DIN 17052-1 see page 76
- Bottom heating protected by SiC tiles on the bogie providing level stacking surface for the 850 °C models
- Furnace chamber fitted with inner sheets made of stainless steel 1.4301 for 600 °C models and of 1.4828 for 850 °C models

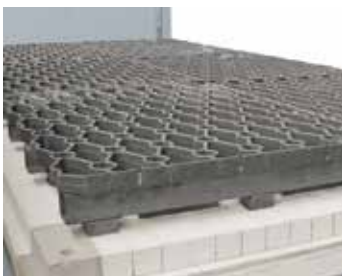

Charging grid in a forced convection bogie hearth furnace for even load distribution



- Insulation structured with high-quality mineral wool for 600 °C models
- Insulation made of high-quality, non-classified fiber material for 850 °C models
- Bogies with flanged wheels running on rails for easy and precise movement of heavy loads

Forced convection bogie hearth furnace for heat-treating coils

- Electric chain-driven bogie in combination with rail operation for smooth movement of heavy loads from model W 4800
- Over-temperature limiter with manual reset for thermal protection class 2 in accordance with EN 60519-2 as temperature limiter to protect the furnace and load
- Defined application within the constraints of the operating instructions
- NTLog Basic for Nabertherm controller: recording of process data with USB-flash drive
- Controls description see page 80

Additional equipment

- Direct gas heating or upon request with indirect gas heating with radiation tube
- Electric chain-driven bogie in combination with rail operation for smooth movement of heavy loads up to Model W 4000
- Optimization of the temperature uniformity up +/- 3 °C according to DIN 17052-1 see page 76
- Bogie running on steel wheels with gear rack drive, no rails in front of the furnace necessary
- Different possibilities for an extension to a bogie hearth furnace plant:
 - Additional bogies
 - Bogie transfer system with parking rails to exchange bogies running on rails or to connect multiples furnaces
 - Motor-driven bogies and cross-traversal system
 - Fully automatic control of the bogie exchange
- Electro-hydraulic lift door
- Motor-driven exhaust air flaps, adjustable via the program
- Uncontrolled or controlled cooling system with frequency-controlled cooling fan and motor-driven exhaust air flap
- Multi-zone control adapted to the particular furnace model provides for optimum temperature uniformity in the 850 °C models
- Commissioning of the furnace with test firing and temperature uniformity measurement (also with load) for the purpose of process optimization
- Designed for Tmax 950 °C, fan blade driven indirectly via a belt to protect the air recirculation motor against over-heating
- Process control and documentation via VCD software package or Nabertherm Control Center (NCC) for monitoring, documentation and control see page 80



Forced convection bogie hearth furnace W 10430/85AS



Forced convection bogie hearth furnace W 13920/60AS4 with bottom grid for heavy loads

Model	Tmax °C	Inner dimensions in mm			Volume in l	Outer dimensions in mm			Heating power in kW ¹	Electrical connection*
		w	d	h		W	D	H		
W 1000/.. A	600 or 850	800	1600	800	1000	1800	2390	2305	45.0	3-phase
W 1600/.. A		1000	1600	1000	1600	2000	2390	2535	45.0	3-phase
W 2200/.. A		1000	2250	1000	2200	2000	3040	2535	90.0	3-phase
W 3300/.. A		1200	2250	1200	3300	2200	3040	2745	90.0	3-phase
W 4000/.. A		1500	2250	1200	4000	2500	3040	2780	110.0	3-phase
W 4800/.. A		1200	3300	1200	4800	2200	4090	2780	110.0	3-phase
W 6000/.. A		1500	3300	1200	6000	2500	4090	2900	140.0	3-phase
W 6600/.. A		1200	4600	1200	6600	2200	5390	2770	140.0	3-phase
W 7500/.. A		1400	3850	1400	7500	2400	4640	2980	140.0	3-phase
W 8300/.. A		1500	4600	1200	8300	2500	5390	2780	185.0	3-phase

¹Depending on furnace design connected load might be higher

*Please see page 81 for more information about supply voltage

Bogie Hearth Furnaces Electrically Heated



Bogie hearth furnace W 2200/S with exchangeable table system



Bogie hearth furnace W 7500 with bogie, separated in three parts



Fiber insulation and meander shaped heating elements for short process times

For annealing and hardening of larger parts, for example heavy cast parts or tool steel dies to temperatures between 800 °C and 1100 °C, we recommend our bogie hearth furnaces with radiation heating. The bogie can be loaded outside the furnace. When the design includes an electro-hydraulic lift door and a motorized bogie, the furnace can be opened while hot and the load can be removed for cooling or quenching. When several bogies are used together with a second door or bogie transfer system, one bogie can be loaded outside the furnace while the other bogie is in the furnace. This shortens process times and the residual energy of the furnace can be used when the new charge is heated.

- Tmax 900 °C or 1280 °C
- Dual shell housing with rear ventilation, provides low shell temperatures
- Swing door hinged on the right side
- Heating from five sides (four sides and bogie) provides for a optimum temperature uniformity
- Bogie heating receives power via blade contacts when driven in
- Heating elements mounted on support tubes provide for free radiation and long service life
- Bottom heating protected by SiC tiles on the bogie providing level stacking surface
- Multi-layer insulation consisting of lightweight refractory bricks backed by microporus silica insulation
- Self-supporting and long-life ceiling construction with bricks laid in arched construction
- Bogies with flanged wheels running on rails for easy and precise movement of heavy loads
- Adjustable air inlet damper
- Manual exhaust air flap on the furnace roof

- Over-temperature limiter with adjustable cutout temperature for thermal protection class 2 in accordance with EN 60519-2 as temperature limiter to protect the furnace and load
- Defined application within the constraints of the operating instructions
- NTLog Basic for Nabertherm controller: recording of process data with USB-flash drive
- Controls description see page 80

Additional equipment

- Fiber insulation also in combination with meander shaped heating elements for short heating times
- Electric chain-driven bogie in combination with rail operation for smooth movement of heavy loads
- Bogie running on steel wheels with gear rack drive, no rails in front of the furnace necessary
- Different possibilities for an extension to a bogie hearth furnace plant:
 - Additional bogies
 - Bogie transfer system with parking rails to exchange bogies running on rails or to connect multiples furnaces
 - Motor-driven bogies and cross-traversal system
 - Fully automatic control of the bogie exchange
- Electro-hydraulic lift door
- Motor-driven exhaust air flap
- Uncontrolled or controlled cooling system with frequency-controlled cooling fan and motor-driven exhaust air flap
- Multi-zone control adapted to the particular furnace provides model for optimal the temperature uniformity
- Commissioning of the furnace with test firing and temperature uniformity measurement (also with load) for the purpose of process optimization
- Process control and documentation via VCD software package or Nabertherm Control Center (NCC) for monitoring, documentation and control see page 80



Bogie running on steel wheels with gear rack drive, no rails necessary



Bogie hearth furnace with gas supply system



Furnace plant with bogie transfer system in production



Bogie hearth furnace W 8250/S

Bogie Hearth Furnaces Electrically Heated

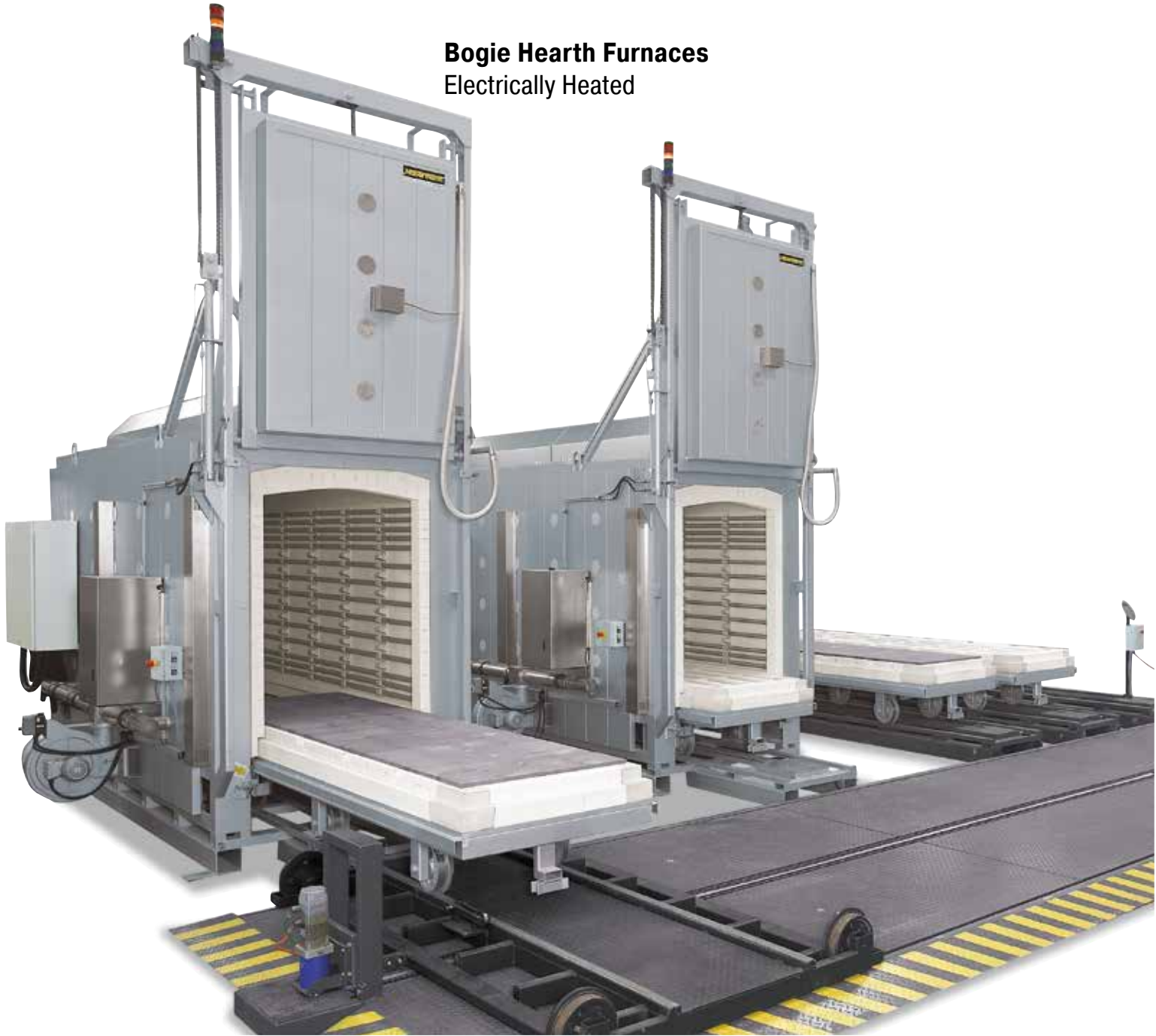

Combi furnace plant consisting of two bogie hearth furnaces W 5000/H and two additional bogies incl. bogie transfer system and incl. necessary park rails



Bogie hearth furnace W 6340S

Model	Tmax °C	Inner dimensions in mm			Volume in l	Outer dimensions in mm			Heating power in kW ¹	Electrical connection*	Weight in kg
		w	d	h		W	D	H			
W 1000/G	900	800	1600	800	1000	1470	2410	1915	40	3-phase	3000
W 1500/G	900	900	1900	900	1500	1570	2710	2030	57	3-phase	3500
W 2200/G	900	1000	2200	1000	2200	1670	3010	2140	75	3-phase	4500
W 3300/G	900	1000	2800	1200	3300	1670	3610	2355	110	3-phase	5300
W 5000/G	900	1000	3600	1400	5000	1670	4410	2555	140	3-phase	7300
W 7500/G	900	1000	5400	1400	7500	1670	6210	2555	185	3-phase	10300
W 10000/G	900	1000	7100	1400	10000	1670	7910	2555	235	3-phase	12500
W 1000	1280	800	1600	800	1000	1470	2410	1915	57	3-phase	3000
W 1500	1280	900	1900	900	1500	1570	2710	2030	75	3-phase	3500
W 2200	1280	1000	2200	1000	2200	1670	3010	2140	110	3-phase	4500
W 3300	1280	1000	2800	1200	3300	1670	3610	2355	140	3-phase	5300
W 5000	1280	1000	3600	1400	5000	1670	4410	2555	185	3-phase	7300
W 7500	1280	1000	5400	1400	7500	1670	6210	2555	235	3-phase	10300
W 10000	1280	1000	7100	1400	10000	1670	7910	2555	300	3-phase	12500

¹Depending on furnace design connected load might be higher

*Please see page 81 for more information about supply voltage

Gas-Fired Bogie Hearth Furnaces up to 1400 °C for Firing or Sintering in Air or under Reducing Atmosphere



Combi furnace plant consisting of one gas-fired bogie hearth furnace WB 11000/HS and two additional bogies incl. bogie transfer system and incl. necessary park rails

Gas-fired bogie hearth furnaces distinguish by their unique efficiency. The use of high-speed burners allows for short heating times. The burners are arranged according to the furnace geometry providing for a optimum temperature uniformity. Depending on the furnace dimensions, the burners can alternatively be equipped with recuperator technology to save energy. The high-quality, long-life fiber insulation with storage capacity provides for short heating and cooling times.

- Tmax up to 1400 °C, depending on furnace design
- Powerful, sturdy high-speed burner with pulse control and special flame control in the furnace chamber provide for optimum temperature uniformity
- Operation with city gas, natural gas or liquified gas
- Fully automatic PLC control of the temperature as well as monitoring of the burner function
- Reduction-resistant fiber insulation with low heat storage provides for short heating and cooling times
- Dual shell housing provides for low outside temperatures
- Exhaust hood with fittings for further discharge of the exhaust gases
- Over-temperature limiter with adjustable cutout temperature for thermal protection class 2 in accordance with EN 60519-2 as temperature limiter to protect the furnace and load
- Defined application within the constraints of the operating instructions
- Controls description see page 80

Additional equipment

- Automatic lambda control to set the furnace atmosphere
- Exhaust air and exhaust gas piping
- Recuperator burners utilizing part of the waste heat in the exhaust tract to preheat the combustion air and considerably contribute to energy saving
- Thermal exhaust cleaning systems
- Process control and documentation via VCD software package or Nabertherm Control Center (NCC) for monitoring, documentation and control see page 80
- Other additional equipment for bogie hearth furnaces see pages 45



Bogie hearth furnace WB 14880S



Furnace chamber with eight high-speed burners

Chamber Furnaces Gas-Fired



Chamber furnace NB 2880/S



Chamber furnace NB 4330/S

Certain heat treatment processes require a gas-fired chamber furnace. Short heating times due to the high power are a convincing argument. The chamber furnaces with powerful atmospheric gas burners cover a wide variety of these processes. In the basic version the burners are manually ignited once at the start of the process. The automatic control system then takes over control of the temperature curve. At program end, the burners are automatically switched off. Depending on the process, the furnaces can be equipped with automatically controlled fan burners and safety technology for debinding. Depending on the model, these furnaces can be upgraded with fully automatic fan burners and additional accessories.



Indirect gas firing with radiation tubes

- Tmax 1300 °C
- Powerful, atmospheric burners for operation with liquified gas or natural gas
- Depending on the application, special positioning of the gas burners with flame guidance provides for optimal temperature uniformity
- Fully automatic temperature control
- Gas fittings with flame control and safety valve in accordance with DVGW (German Technical and Scientific Association for Gas and Water)
- Multi-layer, reduction-proof insulation with light-weight refractory bricks and special back-up insulation result in low gas consumption
- Self-supporting and rugged ceiling, bricks laid in arched construction or as fiber insulation
- Exhaust hood
- Over-temperature limiter with adjustable cutout temperature for thermal protection class 2 in accordance with EN 60519-2 as temperature limiter to protect the furnace and load
- Defined application within the constraints of the operating instructions
- Controls description see page 80

Additional equipment

- Fan burner with fully automatic control
- Indirect gas firing with radiation tubes for flame protection of the charge
- Exhaust air and exhaust gas piping
- Thermal or catalytic exhaust cleaning systems
- Recuperator technology for heat recovery see page 69
- Process control and documentation via VCD software package or Nabertherm Control Center (NCC) for monitoring, documentation and control see page 80



Compact burners for standard models up to NB 600

Chamber Furnaces Electrically Heated



Chamber furnace N 41/H



Chamber furnace N 321 with charging stacker

These universal chamber furnaces with radiation heating have been specifically designed to withstand heavy-duty use in the heat treatment shop. They are particularly useful for processes such as tool making or for hardening jobs, e.g. annealing, hardening and forging. With help of various accessories, these furnaces can be customized to your application requirements.

- Compact, robust design
- Three-sides heating: from both side walls and bottom
- Heating elements on support tubes ensure free heat radiation and a long service life
- Bottom heating protected by heat conducting SiC tiles
- Stainless steel upper door jamb protects furnace structure when furnace is opened hot
- Base frame included in the delivery, N 7/H - N 17/HR designed as table-top model
- Exhaust opening in the side of the furnace, or on rear wall of chamber furnace in the N 31/H models and higher
- Temperature uniformity up to +/- 10 °C according to DIN 17052-1 see page 76
- Low energy consumption due to multi-layer insulation
- Gas spring dampers provide for easy door opening and closing
- Heat resistant zinc paint for protection of door and door frame (for model N81 and larger)
- Defined application within the constraints of the operating instructions
- NTLog Basic for Nabertherm controller: recording of process data with USB-flash drive
- Controls description see page 80



Chamber furnace N 27/HS for forging with pneumatic door movement and radiation exhaust curtain

Additional equipment see page 50/51

Model	Tmax °C	Inner dimensions in mm			Volume in l	Outer dimensions in mm			Heating power in kW ³	Electrical connection*	Weight in kg
		w	d	h		W	D	H			
N 7/H ¹	1280	250	250	140	9	800	650	600	3.0	1-phase	60
N 11/H ¹	1280	250	350	140	11	800	750	600	3.5	1-phase	70
N 11/HR ¹	1280	250	350	140	11	800	750	600	5.5	3-phase ²	70
N 17/HR ¹	1280	250	500	140	17	800	900	600	6.4	3-phase ²	90
N 31/H	1280	350	350	250	30	1040	1100	1340	15.0	3-phase	210
N 41/H	1280	350	500	250	40	1040	1250	1340	15.0	3-phase	260
N 61/H	1280	350	750	250	60	1040	1500	1340	20.0	3-phase	400
N 87/H	1280	350	1000	250	87	1040	1750	1340	25.0	3-phase	480
N 81	1200	500	750	250	80	1140	1900	1790	20.0	3-phase	820
N 161	1200	550	750	400	160	1180	1930	1980	30.0	3-phase	910
N 321	1200	750	1100	400	320	1400	2270	2040	47.0	3-phase	1300
N 641	1200	1000	1300	500	640	1690	2670	2240	70.0	3-phase	2100
N 81/13	1300	500	750	250	80	1220	1960	1840	22.0	3-phase	900
N 161/13	1300	550	750	400	160	1260	1990	2030	35.0	3-phase	1000
N 321/13	1300	750	1100	400	320	1480	2330	2090	60.0	3-phase	1500
N 641/13	1300	1000	1300	500	640	1770	2730	2290	80.0	3-phase	2500

¹Table-top model

²Heating only between two phases

*Please see page 81 for more information about supply voltage

³Depending on furnace design connected load might be higher



Chamber furnace N 7/H

Chamber Furnaces, Sheet Metal Preheating Furnaces Electrically Heated



These very rugged chamber furnaces with radiation heating are designed for continuous heat-treatment processes. They are ideally suited for forming processes such as forging or hot forming steel sheets. The use of a wide variety of accessories enables these furnaces to be tailored to the relevant application.

Chamber furnace with electro-hydraulic lift door on transportable base for preheating of large steel sheets for the automotive industry.



Door heating element as additional equipment

- Tmax 1200 °C
- Very rugged design
- Heating from three sides (both sides and the bottom)
- Heating elements installed on ceramic support tubes enable unimpaired heat radiation
- Bottom heating protected by heat-conducting SiC plate
- Manual lift door for chamber furnaces to N 951
- Electro-hydraulic lift door for chamber furnaces from N 1296
- Heating operated with low-wear semi-conductor relay (for models to 60 kW) see page 49
- Temperature uniformity up to +/- 10 °C according to DIN 17052-1 see page 76
- Closable measuring port for customer's temperature measuring system
- Holding time measurement for the charge until it goes to forging or forming of steel sheets: After charging, the operator presses a key and the previously defined holding time for the load begins to run. The end of the holding time is indicated by both acoustic and optical signals, meaning that the charge can be removed.
- Heat resistant zinc paint for protection of door and door frame
- Defined application within the constraints of the operating instructions
- NTLLog Basic for Nabertherm controller: recording of process data with USB-flash drive
- Controls description see page 80

Additional equipment

- Other temperatures on request
- SiC plates to protect the wall heating elements
- Electro-hydraulic lift door for models to N 951
- Protective gas ports in combination with silicone sealing of the chamber
- Annealing boxes for powder nitriding, annealing and hardening under non-flammable protective or reaction gases
- Loading devices and charging aids
- Charging grates for heavy loads
- Cooling fan in combination with motor-driven exhaust air flaps in the top of the furnace
- Heating elements also in door and rear wall for optimized temperature uniformity up to +/- 5 °C according to DIN 17052-1 see page 76



Chamber furnace N 6080/13S preheating furnace for forging; with door-in-door



Furnace to preheat the press ram of a hot forging plant

- Commissioning of the furnace with test firing and temperature uniformity measurement using 11 thermocouples including record of the measurement results
- Furnace chamber with optional heating elements in the ceiling when used for preheating of sheetmetal plates
- Process control and documentation via VCD software package or Nabertherm Control Center (NCC) for monitoring, documentation and control see page 80



Chamber furnace N 1491/S in production

Model	Tmax °C	Inner dimensions in mm			Volume in l	Outer dimensions in mm			Heating power in kW ¹	Electrical connection*
		w	d	h		W	D	H		
N 731	1200	750	1300	750	730	1800	2400	2890	70	3-phase
N 761	1200	800	1900	500	760	1740	2700	2650	70	3-phase
N 891	1200	800	1400	800	890	1740	2200	3450	70	3-phase
N 951	1200	1000	1900	550	950	2060	2700	2780	70	3-phase
N 1296	1200	1800	1200	600	1296	2860	2000	3020	70	3-phase
N 1491	1200	1660	1200	750	1490	2720	2000	3350	110	3-phase
N 1501	1200	1000	1500	1000	1500	2060	2300	3845	95	3-phase
N 1601	1200	1600	2000	500	1600	2660	2900	2900	110	3-phase
N 1760	1200	2200	1600	500	1760	3400	2500	2900	110	3-phase
N 1771	1200	1400	1400	900	1770	2460	2200	3745	110	3-phase
N 2161	1200	1700	1700	750	2160	2760	2600	3350	110	3-phase
N 2201	1200	1000	2200	1000	2200	2060	3000	3845	150	3-phase
N 2251	1200	2500	1500	600	2250	3560	2300	3020	110	3-phase
N 2401	1200	2500	1200	800	2400	3560	2000	3445	110	3-phase

¹Depending on furnace design connected load might be higher

*Please see page 81 for more information about supply voltage



Furnace chamber with optional heating elements in the ceiling when used for preheating of sheetmetal plates

Chamber Furnaces for Heat Cleaning Gas-Fired with Integrated Thermal Afterburner



Chamber furnace NB 2300 CL



Chamber furnace NB 2750/65 CL



Before



After

The chamber furnaces in the model series NB .. CL are used for heat cleaning of components. An optimum temperature uniformity is not a priority for these processes. Examples are heat cleaning of electric motors, coated surfaces of steel components or the nozzles of plastic injection molding machines.

The furnaces are gas-fired and have an integrated thermal afterburner system which is also gas-fired. The pre-set, low-oxygen respectively reducing atmosphere in the chamber furnace effectively prevents spontaneous combustion at the workpiece and subsequent damage as a result of over-temperature.

For safe operation, the furnace door locks after program start and cannot be opened again until the temperature has dropped below 180 °C at the process end. In case of a burner flame malfunction or gas shortage the process is aborted. In addition, the control system is equipped with an over-temperature limiter with manual reset that is set by the customer at a safe cut-off temperature to switch off the chamber furnace if the limit is exceeded.

The chamber furnaces are not suitable for components and coatings that contain solvents or a high concentration of water. These models must also not be used for charges with low flash points such as wood, paper or wax.

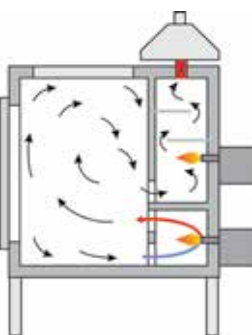

- Tmax 500 °C
- Furnace housing with equipped for safe transport with forklift
- Furnace chamber size dimensioned to hold standard lattice boxes
- Furnace chamber insulation made of non-classified fiber material, bottom and rear wall insulated with lightweight refractory bricks
- High performance, atmospheric burner fueled by liquified gas or natural gas
- Completely automated temperature controls
- Integrated thermal afterburner for exhaust gas cleaning
- Defined application within the constraints of the operating instructions
- Controls description see page 80



Gas burners for furnace heating and thermal afterburner

Model	Tmax °C	Inner dimensions in mm			Outer dimensions in mm			Burner rating furnace chamber in kW	Burner ratingTNV in kW
		w	d	h	W	D	H		
NB 1300 CL	500	1200	900	1000	2160	2310	2450	50	100
NB 2300 CL	500	1200	1200	1600	2160	2605	3050	100	100
NB 2500 CL	500	1200	1600	1300	2160	3000	2750	100	100
NB 2750/65 CL	650	1200	1200	1900	2160	2605	3150	100	80

Chamber Furnaces for Processes with High Vaporization Rates of Organic Matter or for Thermal Cleaning by Ashing

Electrically Heated or Gas-Fired

The chamber furnaces of the model series N .. BO are used for processes with large amounts of organic matters or high vaporization rates. Processes in which the product or contaminations on the product are ashed by ignition can be also carried out safely in this type of chamber furnace. Examples include residual wax removal of pouring clusters followed by sintering, or thermal cleaning of oxide catalytic honey combs from soot or fuel residues. The chamber furnaces are electrically heated or gas-fired. The electrically heated furnaces, for safety reasons, are equipped with an integrated gas torch for igniting the flammable components in the gas mixture. The accumulation of flammable components is avoided and their safe combustion is ensured.

The furnace series is suitable for products that will not be damaged by a temporary, uncontrolled temperature rise.

The burning of unwanted organic ingredients can take place at temperatures > 500 °C. Following this, a subsequent process can take place up to max. 1000 °C or 1400 °C (electrically) or 1000 °C (gas-fired).

For safety, the furnace door locks after the program was started and cannot be opened again until the temperature has dropped below a defined value. In case of burner malfunction or gas shortage the process is aborted.

Chamber furnaces N 100 BO - N 650/14 BO, electrically heated and gas-fired ignition flame

- Tmax 1000 °C or 1400 °C
- Standard sizes up to 650 liters furnace chamber, additional sizes on request
- Exhaust hood
- Fully automatic temperature control
- Optional thermal afterburning
- Ignition flame using natural gas or liquid gas (LPG)
- Defined application within the constraints of the operating instructions
- Controls description see page 80

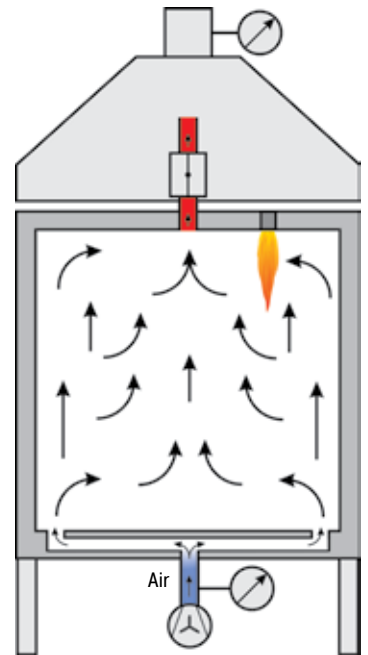

Model	Tmax °C	Inner dimensions in mm			Outer dimensions in mm			Heating power in kW ¹
		w	d	h	W	D	H	
N 100 BO	1000	400	530	460	1200	1300	2100	9
N 300 BO	1000	550	700	780	1350	1450	2200	20
N 300/14 BO	1400	550	700	780	1350	1450	2200	30
N 650/14 BO	1400	700	850	1100	1700	1900	2700	62

¹Depending on furnace design connected load might be higher

Chamber furnaces models NB 300 BO and NB 650 BO, gas-fired

- Tmax 1000 °C
- Standard sizes up to 650 liters furnace chamber, additional sizes on request
- Integrated thermal afterburning
- Gas burners operating with natural gas or liquid gas (LPG)
- Defined application within the constraints of the operating instructions
- Controls description see page 80



Chamber furnace N 650/14 BO with ignition burner

Model	Tmax °C	Inner dimensions in mm			Outer dimensions in mm			Output burner in kW
		w	d	h	W	D	H	
NB 300 BO	1000	550	700	780	1250	1650	3000	100
NB 650 BO	1000	700	850	1100	1600	2100	3150	200

Top Hat Furnaces or Bottom Loading Furnaces with Wire Heating up to 1400 °C



Top hat furnace plant with three exchangeable tables and protective gas boxes for heat treatment with non-flammable protective or reaction gases

Top hat furnaces and bottom loading furnaces have the advantage that they are highly accessible for charging. The heating from all four sides and the table provides for very uniform temperatures. The basic furnace is equipped with a fixed table under the top hat. The system can be expanded by adding one or several exchangeable tables which can be driven manually or motorically. Another option is to remove the top hat completely with a shop crane. In such cases, the furnace heating system has a plug-in power supply.

- Tmax 1280 °C
- Dual shell housing with rear ventilation for low shell temperatures



Production plant, consisting of 3 top hat furnaces HAS 1560/95S with sealed housing for operation with nitrogen. Including air/gas heat exchanger for reduced cooling times

- Top hat furnaces: electrohydraulically driven hat with fixed table
- Bottom loading furnaces: driven table and fixed hat
- Five-sided heating from all four sides and from the table provides for a temperature uniformity up to +/- 10 °C according to DIN 17052-1 see page 76
- Heating elements mounted on support tubes provide for free radiation and long service life of the heating wire
- Bottom heating protected by SiC tiles which provide for a level stacking surface
- Multi-layer insulation consisting of lightweight refractory bricks backed by special insulation
- Long-life ceiling design with fiber insulation
- Manual exhaust air flap on the furnace roof
- Over-temperature limiter with adjustable cutout temperature for thermal protection class 2 in accordance with EN 60519-2 as temperature limiter to protect the furnace and load
- Defined application within the constraints of the operating instructions



Top hat furnace H 1600/14



Top hat furnace H 500 with catalytic post combustion system, automatic table changing system and safety scanners to protect the danger zone

- NTLog Basic for Nabertherm controller: recording of process data with USB-flash drive
- Controls description see page 80

Additional equipment

- Tmax to 1400 °C
- Motor driven exhaust air flap, switchable via the program
- Uncontrolled or controlled cooling system with frequency-controlled cooling fan and motor-driven exhaust air flap
- Protective gas connection for purging the furnace with non-flammable protective or reaction gases
- Manual or automatic gas supply systems
- Multi-zone control adapted to the particular furnace provides model for optimal the temperature uniformity
- Commissioning of the furnace with test firing and temperature uniformity measurement (also with load) for the purpose of process optimization
- Additional tables, table changing system, also motor-driven
- Exhaust air and exhaust gas piping
- Process control and documentation via VCD software package or Nabertherm Control Center (NCC) for monitoring, documentation and control see page 80



Top hat furnace system H 245/LTS with cooling station and table changing system

Model	Tmax °C	Inner dimensions in mm			Volume in l	Outer dimensions in mm			Heating power in kW ¹	Electrical connection*	Weight in kg
		w	d	h		W	D	H			
H 125/LB, LT	1280	800	400	400	125	1550	1500	2200	12	3-phase	1250
H 250/LB, LT	1280	1000	500	500	250	1530	1700	2300	18	3-phase	1400
H 500/LB, LT	1280	1200	600	600	500	2020	1800	2500	36	3-phase	1800
H 1000/LB, LT	1280	1600	800	800	1000	2200	2000	2900	48	3-phase	2800
H 1350/LB, LT	1280	2800	620	780	1360	3750	2050	3050	75	3-phase	3500
H 3000/LB, LT	1280	3000	1000	1000	3000	4000	2100	3200	140	3-phase	6200

¹Depending on furnace design connected load might be higher

*Please see page 81 for more information about supply voltage



Kiln furniture for small ceramics components

Charging Devices and Accessories for Chamber and Bogie Hearth Furnaces

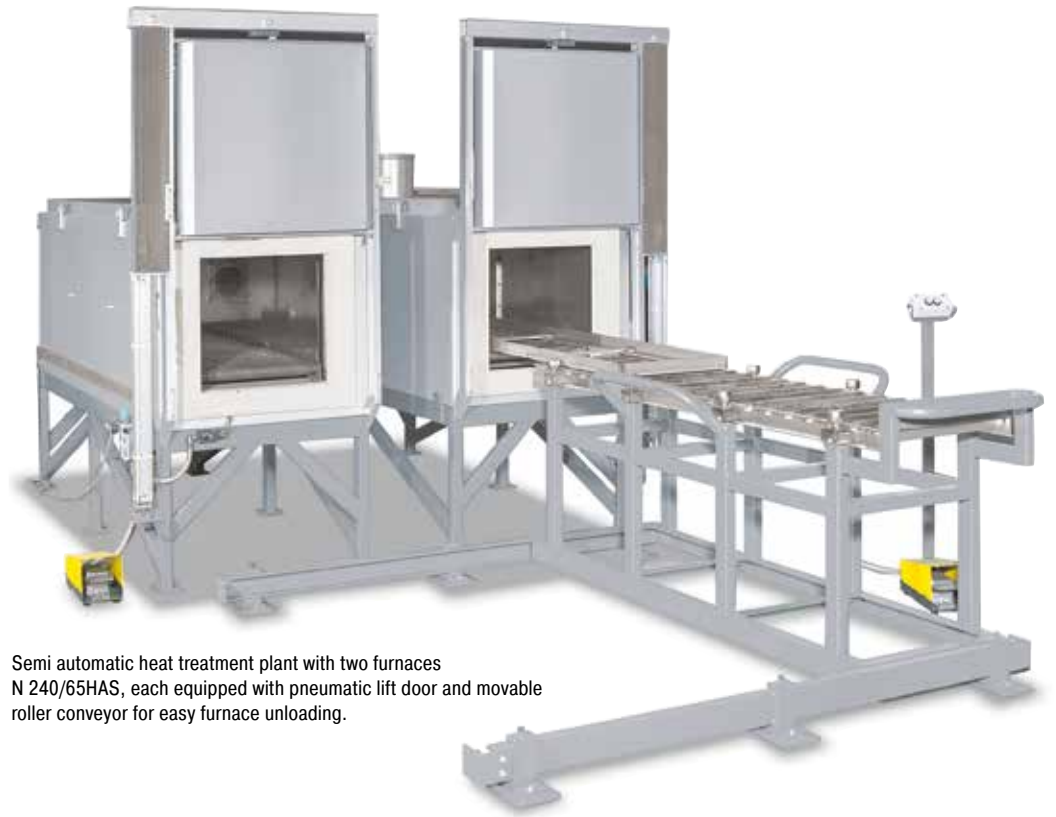

Semi automatic heat treatment plant with two furnaces N 240/65HAS, each equipped with pneumatic lift door and movable roller conveyor for easy furnace unloading.

By upgrading a furnace with useful accessories and devices for charging, you can considerably accelerate and simplify your heat processing which increases your productivity. The solutions shown on the following pages are only a part of our program, available in this product range. Ask us about accessories you may need. Our team of skilled engineers is prepared to develop a custom solution with you for any particular problem.



Chamber furnace system consisting of two forced convection furnaces N 60/65 HA with electric swing door opening for cooling and convenient furnace charging



Forced convection furnace with charging grill shelves. The shelves can be moved individually on telescoping guides and can be taken out individually.



N 2380/55 HAS
Forced convection furnace plant with charging cart for sheet metal tempering

Quench Tanks

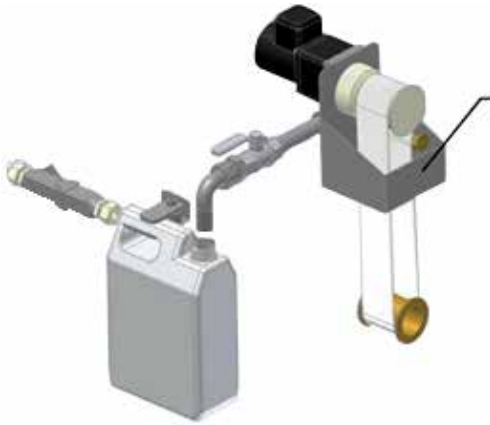

Oil separator for quench tanks with water



Subject to process, charge size and weight a customized quench tank will be designed and delivered. Standard sizes are also available. Water, oil or polymer are available as quenching medium. Various examples of different quench tank design as part of tempering plants for steel and non-ferrous metals are described on page 72.

Available quenching mediums:

- Water
- Oil
- Polymer

Design Specifications

- Powerful circulation of the quenching medium
- Controlled heating systems
- Fill-level control
- Automatic refill system in case of water as quenching medium
- Connection port for customer's cooling system
- Cooling system for the quenching medium
- Oil separator for quench tanks with water
- Protective gas supply on the surface of oil quench tanks as fire protection
- Integration of bath temperature in the process control and documentation



Quench tank with water integrated in a tempering plant for aluminium



Protective gas supply as fire protection



Powerful circulation of quenching medium



Circulation of quenching medium

Protective Gas and Carburization Systems for Annealing and Hardening



Annealing box

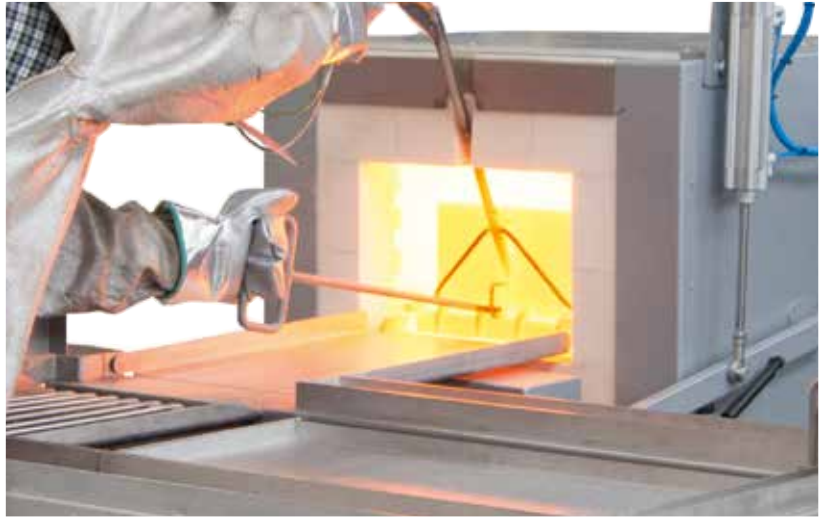

Annealing tray with alloy bag and protective gas inlet



Annealing box with protective gas inlet and outlet



Annealing box with protective gas inlet and outlet, constructed for evacuation at ambient temperatures

Our protective gas and carburization modules allow you to upgrade our chamber furnaces into a compact annealing and hardening system for non-flammable protective or reaction gases as an economical alternative to expensive vacuum systems and protective gas hardening furnaces. We can recommend different systems based on your application. Our professional test center will be pleased to test your product samples in order to specify the right heat treatment equipment for you.

■ Annealing Box

Our annealing boxes with lid sealing may be used for carburizing, annealing and hardening in neutral atmospheres, powder nitriding or boriding. Your charge is placed in the box and bedded in carburizing granulate, neutral annealing coal or nitriding or boriding powder. The box is sealed, and when heated, the resulting atmosphere in the closed annealing box provides for the respective surface reaction of the charge. For carburizing and similar processes, the annealing box may be removed while hot, opened and the charge quenched in fluid. For annealing processes, the box may remain in the furnace until it is cooled down.

■ Annealing Tray with Alloy Bag

This system, consisting of a lightweight tray with gas port and alloy bag, is particularly useful for air-quenched steels. The thin-walled annealing tray allows fast heat transfer. Its protective gas connections allow you to process your charge in a defined atmosphere. The small size of the gas lightweight tray you to pre-flush or cool the unit outside the furnace or place it on a cooling table for fast cooling by fan.

■ Annealing Box with Protective Gas Inlet and Outlet

The boxes are equipped with lid and protective gas inlet and outlet. The lid is sealed by means of a sealing channel with a high-temperature rope gasket before it is introduced into the furnace. The furnace is equipped with a special passage for the protective gas connections. The box is connected to a gas supply panel to introduce the required atmosphere in the box. When the heating process is finished, the box may be removed from the furnace, the lid removed and the parts quenched in liquid or air.

■ Annealing Box with Protective Gas Inlet and Outlet constructed for Evacuation Ambient Temperatures

This version of our annealing box is designed to be evacuated prior to the heating cycle. After evacuation, the box is refilled with a protective atmosphere for the heating cycle. This system is particularly useful for bright hardening of bulk materials, and nonferrous and noble metals, since oxygen can be more efficiently removed from the box by evacuation than through purging. Temperature-resistant seals allow this version of the annealing box to maintain a vacuum at ambient temperatures.

■ Additional Accessories

Nabertherm offers a wide range of hardening accessories for the a.m. heat treatment system. From the simple sealing cord for the gas supply box up to a fully automatic gas supply system, we offer interesting solutions for your problem. Please ask for our catalog Thermal Process Technology II.



Powder nitriding in an annealing box



Heat treatment under protective gas atmosphere in a gas-supply box incl. charge thermocouple



Protective gas box used in a large bogie hearth furnace with air circulation



Annealing box with flap which opens together with the furnace door



Hardening in annealing tray with alloy bag



Bulk material bright annealing in an annealing box with evacuation facility

Salt-Bath Furnaces for Heat Treatment of Steel or Light Metals

Electrically Heated or Gas-Fired



Salt-bath furnace TS 40/30, electrically heated



Salt-bath furnace TSB 30/30, gas-fired



Salt-bath furnace TS 30/18 with preheating chamber above the salt bath and charging aid for immersion of the charge

Salt-bath furnaces offer remarkably high temperature uniformity and excellent heat transfer to the work piece. Our salt-bath furnaces TS 20/15 - TSB 90/80 are especially useful for heat-treating of metals in neutral or active salt baths. Processes such as carbonitriding (e.g. Tenifer) up to 600 °C, carburizing up to 950 °C, or bright annealing up to 1000 °C can be realized. In their standard version these salt-bath furnaces are equipped with safety technology for heat treatment of steel. As additional feature they can be equipped with extended safety technology for heat treatment of light metals.

- Tmax 750 °C or 1000 °C in the salt bath
- Safety technology according to EN 60519-2
- Useful for heat treatment of steel
- Salt bath temperature control
- Electric (TS) all-round heating or gas heating (TSB)
- Removable collar plate made of solid steel
- Insulated swing-a-way lid

- Temperature uniformity up to +/- 2 °C according to DIN 17052-1 in the salt bath see page 76
- Over-temperature limiter with manual reset in the furnace chamber to prevent dangerous conditions for the furnace or personnel
- Salt bath control of salt bath and furnace chamber
- Defined application within the constraints of the operating instructions
- Controls description see page 80

Crucibles

- Type P: low carbon steel and CrNi plated for carburizing, neutral salt and annealing baths up to 850 °C
- Type C: high alloy CrNi steel for neutral salt and annealing baths up to 1000 °C and for dip brazing of Aluminium

Additional equipment

- Exhaust gas collection at rim for connection to an exhaust system
- Enhanced safety systems for heat treatment of aluminium and magnesium in the salt bath with second over-temperature limiter with manual reset and PLC-bath control with thermocouples in the salt bath and in the furnace chamber
- Process control and documentation via VCD software package or Nabertherm Control Center (NCC) for monitoring, documentation and control see page 80

Model	Tmax °C ²	Inner dimensions salt-bath crucible		Volume in l	Outer dimensions in mm			Heating power in kW ¹	Electrical connection*	Weight in kg
		Ø in mm	h in mm		W	D	H			
TS 20/15	750	230	500	20	850	850	800	16	3-phase	650
TS 30/18	750	300	500	30	950	950	800	20	3-phase	700
TS 40/30	750	400	500	60	1050	1050	800	33	3-phase	750
TS 50/48	750	500	600	110	1150	1150	970	58	3-phase	1000
TS 60/63	750	610	800	220	1250	1250	970	70	3-phase	1200
TS 70/72	750	700	1000	370	1350	1350	1370	80	3-phase	1500
TS 90/80	750	900	1000	500	1600	1600	1400	100	3-phase	1700
TS, TSB 20/20	1000	230	500	20	850	850	800	21	3-phase	650
TS, TSB 30/30	1000	300	500	30	950	950	800	33	3-phase	700
TS, TSB 40/40	1000	400	500	60	1050	1050	800	44	3-phase	750
TS, TSB 50/60	1000	500	600	110	1150	1150	970	66	3-phase	1000
TS, TSB 60/72	1000	610	800	220	1250	1250	970	80	3-phase	1200
TS, TSB 70/90	1000	700	1000	370	1350	1350	1370	100	3-phase	1500
TS, TSB 90/80	1000	900	1000	500	1600	1600	1400	120	3-phase	1700

¹Depending on furnace design connected load might be higher

²Salt bath temperature

*Please see page 81 for more information about supply voltage

Martempering Furnaces using Neutral Salts Electrically Heated

QS 20 - QS 400 martempering furnaces are filled with neutral salt and offer remarkably rapid and intensive heat transmission to the workpiece while ensuring optimum temperature uniformity. For working temperatures at between 180 °C and 500 °C these martempering furnaces are ideal for quenching or cooling with minimal workpiece distortion, retempering, austempering for optimal toughness, recrystallization annealing after electrical discharge machining (EDM) and for blueing.

The quenching or cooling process is applied in order to achieve an even temperature uniformity throughout the workpiece's entire cross-section before the formation of martensite and to avoid distortion and formation of cracks in valuable mechanical components during the subsequent hardening process.

Tempering in a martempering bath is the same as the tempering process in forced convection furnace and is used to reduce a previously hardened workpiece to a desired hardness, to increase toughness and reduce stress within the workpiece.

Austempering is a good choice to achieve a high level of toughness and dimensional accuracy in oil hardened low-alloy steels. Workpieces subject to austempering have high tensile strength and good elasticity.

- Tmax 500 °C
- Optimal temperature uniformity
- Martemper bath temperature control
- Over-temperature limiter with adjustable cutout temperature for thermal protection class 2 in accordance with EN 60519-2 as temperature limiter to protect the furnace and load
- Heating with immersion heating elements
- Charging basket
- Defined application within the constraints of the operating instructions
- NTLog Basic for Nabertherm controller: recording of process data with USB-flash drive
- Controls description see page 80

Additional equipment

- Charging aid mounted on side of furnace
- Process control and documentation via VCD software package for monitoring, documentation and control see page 80

Model	Tmax °C	Inner dimensions in mm			Volume in l	Outer dimensions in mm			Heating power in kW ¹	Electrical connection*	Weight in kg
		w	d	h		W	D	H			
QS 20	500	300	210	460	20	610	580	920	2.6	1-phase	110
QS 30	500	300	210	580	30	610	580	920	3.2	1-phase	140
QS 70	500	400	300	680	70	750	680	980	7.5	3-phase	240
QS 200	500	540	520	880	200	900	900	1200	18.0	3-phase	660
QS 400	500	730	720	980	400	1100	1100	1300	24.0	3-phase	1150

¹Depending on furnace design connected load might be higher

*Please see page 81 for more information about supply voltage

Information about salts by Petrofer and Durferrit and their application

Salt	Application	Working temperature in °C	Comment
AS 135/140	Martempering hardening, tempering, austempering	180 - 500	Not for use with workpieces which are heated up to above 950 °C and salts which contain more than 13 % KCN
AS 220/225	Tempering, austempering	250 - 500	
AS 200/235	Tempering, austempering	280 - 500	Nitrite-free in the as-received condition
AS 200/235	Tempering	340 - 500	



Martempering furnace QS 30 with charging aid



Martempering hardening in practice



Double martempering bath

Rotary Hearth Furnaces up to 1300 °C with and without Air Circulation Electrically Heated or Gas-Fired



Rotary hearth furnace
DH 3020/1480/450/11, movable on rails,
for preheating of molds for two forges

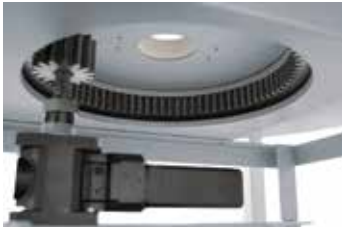

Gear rim drive under the rotary hearth
furnace



Rotary table with base plates made of
highly heat-resistant steel to protect the
insulation



Exhaust hood above charging opening

The rotary hearth furnaces of the DH product line are optimally suited for continuous processes on a small floor space. They are designed for preheating processes such as the preheating of metal parts for forging. Charging and discharging can be done at one position – either by a person or fully automatic. The hearth rotates in pre-set segments individually reconciled with the workpart geometry. The rotational speed and rotational intervals can be defined by the control system or by manual switching.

The rotary hearth furnaces are specifically designed for the required throughput and charge dimensions. They are heated electrically or alternatively gas-fired by means of powerful gas burners. Subject to the temperature range these rotary hearth furnaces are equipped with or without air circulation.

- Tmax 1100 °C, 1200 °C or 1300 °C without air circulation
- Tmax 260 °C, 600 °C or 850 °C with air circulation
- Wire heating elements in the furnace ceiling for furnaces up to 1200 °C
- SiC heating rods in the furnace ceiling for furnaces up to 1300 °C
- Gas heating as an alternative to electrical heating
- Rotary hearth furnaces for 650 °C and 850 °C with powerful air circulation for better heat transfer onto the charge and to optimize the temperature uniformity
- Very compact design compared with continuous furnaces
- Designed for continuous operation at one working temperature
- Table diameter up to 3000 mm
- Hearth movement in defined segments
- Low-vibration movement of the rotary hearth
- Parallel swivel door
- Motor-driven or rotational motion initiated by foot switch
- Furnace bottom can be lowered using a forklift truck for maintenance purposes
- Defined application within the constraints of the operating instructions
- Controls description see page 80



Rotary hearth furnace DH 2100/0/750/13S

Additional equipment

- Exhaust hood above the door opening for discharge of the warm exhaust air when door is open
- Pneumatic drive of the parallel swivel door
- Charging aids for ease of loading and unloading
- Multi-zone control for adjustable thermal profile during the cycle
- Protective gas connections
- Process control and documentation via VCD software package for monitoring, documentation and control see page 80



Pre-heating of steel rings for forging in a rotary hearth furnace

Size examples Model	Tmax °C	Inner dimensions in mm			Volume in l	Outer dimensions in mm			Heating power in kW ¹	Electrical connection*	Weight in kg
		Ø Outer	Ø Inner	h		W	D	H			
DH 1200/-/300/11	1100	1200	0	300	340	2200	2200	2500	54.0	3-phase	1000
DH 1500/800/250/11	1100	1500	800	250	630	2400	2300	2450	21.0	3-phase	1500
DH 3020/1480/450/11	1100	3022	1480	450	2500	4000	4000	2500	98.0	3-phase	3500
DH 2100/0/750/13S	1300	2100	0	750	2600	3364	3364	2701	650.0	gas-fired	8300

¹Depending on furnace design connected load might be higher

*Please see page 81 for more information about supply voltage



Furnace bottom can be lowered for maintenance purposes

Continuous Furnaces

Electrically Heated or Gas-Fired



Continuous furnace plant for working temperatures up to 260 °C with integrated cooling station

Continuous furnace D 1500/3000/300/14 for thermal ageing with mesh belt transport system and subsequent cooling station



Continuous furnaces are the right choice for processes with fixed cycle times such as drying or preheating, curing, aging, vulcanisation or degassing. The furnaces are available for various temperatures up to a maximum of 1400 °C. The furnace design depends on the required throughput, the process requirements for heat treatment and the required cycle time.



Continuous furnace for bulk materials in baskets

The conveyor technology is tailored to the required working temperature, geometry and weight of the charge and to the requirements regarding available space and integration into the process chain. The conveyor speed and the number of control zones are defined by the process specifications.



Roller continuous furnace N 650/45 AS for heat treatment of heavy workparts

Continuous Furnaces

Electrically Heated or Gas-Fired



Conveyor plant D 1600/3100/1200/55, consisting of solution annealing furnace, cooling station and conveyor system



Mesh belt drive in a continuous furnace

Conveyor concepts

- Conveyor belt
- Metal conveyor belt with adjusted mesh gauges
- Drive chain
- Roller conveyors
- Paternoster
- Pusher-type
- Rotary hearth

Heating systems

- Electric heating, radiation or convection
- Direct or indirect gas-fired
- Infrared heating
- Heating with the use of external heat sources



Continuous furnace D 700/10000/300/45S with chain conveyor for 950 °C, gas-fired



Continuous furnace D 1100/3600/100/50 AS for annealing of springs incl. charging and discharging system

Temperature cycles

- Control of working temperature across the whole length of the furnace, such as for drying or preheating
- Automatic control of a process curve applying defined heat-up, dwell and cooling time
- Heat treatment including a final quenching of the charge

Process atmosphere

- In air
- For processes with organic outgassings incl. mandatory safety technology according to EN 1539 (NFPA 86)
- In non-flammable protective or reactive gases such as nitrogen, argon or forming gas
- In flammable protective or reactive gases such as hydrogen incl. the necessary safety technology

Basic configuration criteria

- Conveyor speed
- Temperature uniformity
- Operating temperature
- Process curve
- Work space width
- Charge weights
- Cycle time or throughput
- Length of charge and discharge zone
- Generated exhaust gases
- Specific industry standards such as AMS, CQI-9, FDA etc.
- Other individual customer requirements



Mesh belt drive in continuous furnace D 1100/3600/100/50 AS



Rotary hearth furnace for preheating

Wire and Strand Annealing Furnaces



Strand annealing furnace D 390/S



D 250/S in production

These models are particularly suitable for continuous heat treatment at operation temperatures up to 1200 °C. The modular design allows adjustment to different length and width requirements. The heating elements are mounted on only one side of the furnace and can be changed individually during operation. Optimum temperature uniformity is achieved by means of a multiple zone control system tailored to the furnace dimensions.

■ Tmax 1200 °C

- Modular design, variable length
- Small outer dimensions due to efficient microporous silica insulation
- Special heating elements that can be changed during operation
- Heating from the ceiling
- Optimum temperature uniformity by means of multiple zone control
- Defined application within the constraints of the operating instructions
- Controls description see page 80

Additional equipment

- Gas supply systems for non-flammable or flammable protective or reaction gases including hydrogen in the muffle tubes, with burn off torch and safety technology
- Process and charge documentation
- Double chamber furnace system with parallel chambers for simultaneous operation at different temperatures
- Process control and documentation via VCD software package or Nabertherm Control Center (NCC) for monitoring, documentation and control see page 80



Strand annealing furnaces based on a tube furnace with a length of 6 meters

Model	Tmax °C	Inner dimensions in mm			Volume in l	Outer dimensions in mm			Heating power in kW ¹	Electrical connection*
		w	d	h		W	D	H		
D 20/S	1200	400	1000	50	20	900	1200	1350	9	3-phase
D 30/S	1200	600	1000	50	30	1100	1200	1350	12	3-phase
D 50/S	1200	200	3600	50	50	700	4000	1150	15	3-phase
D 60/S	1200	200	5600	50	60	700	6000	1350	36	3-phase
D 70/S	1200	350	3600	50	70	850	4000	1100	36	3-phase
D 110/S	1200	480	4600	50	110	980	5000	1450	36	3-phase
D 130/S	1200	650	3600	50	130	1150	4000	1150	60	3-phase
D 180/S	1200	480	7600	50	180	980	8000	1350	80	3-phase
D 250/S	1200	950	5600	50	250	1400	6000	1350	80	3-phase
D 320/S	1200	850	7600	100	320	1400	8000	1350	160	3-phase

¹Depending on furnace design connected load might be higher

*Please see page 81 for more information about supply voltage

Energy Efficiency Technology

In face of rising energy prices and stricter environmental regulations there is increasing demand for heat treatment plants with greater energy efficiency.

Depending on the furnace size and the process there is always a certain amount of potential energy which can be recovered from the waste heat and re-used. This is especially true for large furnace plants or long process times which allow for huge energy savings that the additional investment has a short pay-back time. The thermal energy from finished charges can also be used to preheat cold charges which is also an efficient way of saving energy.

The following examples outline engineering alternatives for heat recovery:

Heat Exchangers

The principle of the counterflow heat exchanger is to use the hot exhaust gas coming from the furnace to pre-heat the cold fresh air channelled into the furnace. In many cases, there is no need anymore for a separate fresh air preheating unit. Such a system is recommended if the process requires continuous air exchange in the furnace chamber, such as when tempering silicone, or during drying processes that are covered by the EN 1539 industrial standard.

Recuperator Burners

Large gas-fired heat-treatment furnaces are especially advantageous for the installation of recuperator burners. Recuperator burners also use hot exhaust gas; to pre-heat the combustion air. Depending on the furnace model and the process, substantial energy savings of as much as 25% can be realized by using recuperator burners so that there is a short pay-back time for the additional purchase costs.

Heat Transfer Chambers

Heat transfer chambers, which can also be described as cooling/heating chambers, offer two enormous advantages. For one, they help save energy, and for another, using a heat transfer chamber increases productivity.

The load is removed from the furnace while it is still hot and placed in the heat transfer chamber. The chamber also has room for a new, cold charge. Circulating the air cools the hot charge and, at the same time, preheats the cold charge before it is put into the furnace. Consequently, the furnace heating does not have to provide the thermal energy and through-put capacity of the furnace is increased of the same time.

The above systems for enhancing energy efficiency are only a few examples of technical alternatives. We would be happy to advise you on whether an additional heat recovery module would also be a sensible add-on to your furnace or plant.



Counterflow heat exchanger for the forced convection chamber furnace N 2560/26 ACLS



Recuperator burner for aluminum melting furnace 16 x TBR 110/12 and 2 x TBR 180/12



Heat transfer between a hot and a cold charge



Production plant, consisting of four chamber dryers for moving the load during heat treatment along with a three-stage heat exchanger to optimize energy efficiency

Tempering Plants for Aluminum and Steel





Drop-Bottom Furnaces

Electrically Heated or Gas-Fired



Fully automatic drop-bottom furnace with movable water bath, including holding position for charging and unloading crane

Drop-bottom furnaces are used for solution annealing and subsequent rapid quenching of aluminum alloys. In particular, with thin-walled aluminum components quench delay times of just 5 seconds from when the door begins to open until complete immersion in the quench tank are required. Generally, these requirements can be met only with this furnace design. The drop-bottom furnace stands on a base so that a quench tank can be positioned directly below the furnace. For the quenching process, the furnace bottom moves horizontally to the side. The loaded basket drops out of the furnace into the quench tank guided by wire cables. The lifting system can be controlled automatically or semi-automatically. Because of the broad working temperature range, drop-bottom furnace plants allow complete T6 heat treatments, consisting of solution annealing, quenching, and artificial aging in just one furnace.

Drop-bottom design alternatives

- Drop-bottom furnace with stationary quench tank as a cost-effective, space saving variant
- Drop-bottom furnace with movable quench tank, including holding position for charging and optional unloading crane
- Customized designs with several furnaces, several tanks and several holding positions for fully automatic processing of several charges

System details

- Working temperature range between 80 °C and 600 °C
- Working temperature can be extended to 650 °C
- Heating generally electric; direct or indirect gas heating is also possible
- Air flow, depending on space conditions and charge geometry, horizontal or vertical
- Compliance with relevant aircraft and automobile standards, such as AMS 2750 E, AMS 2770/2771, or CQI-9 as an option

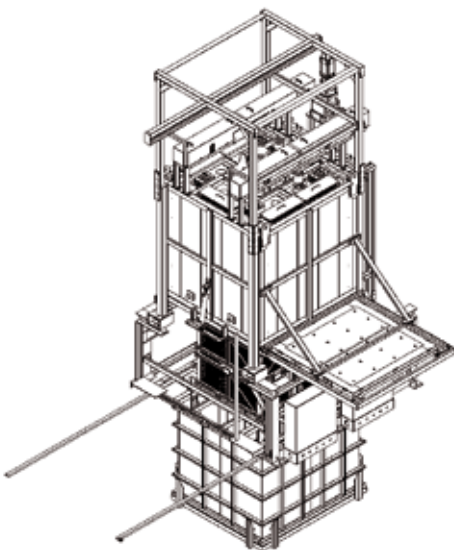

Drop-bottom furnace with stationary quench tank



Fully automatic drop-bottom furnace plant, consisting of two drop-bottom furnaces, movable water bath and several loading and unloading positions

Quench Tanks

Water or polymer quench tanks have a single stainless steel wall and have an integrated circulation system of the quenching medium for effective removal of energy from the charge. Temperature and level are monitored. All tanks have connections for water feed and drainage and a heat exchanger. On request, the quench tank can be equipped with a controlled heating to preheat the quenching medium and/or a heat exchanger for cooling. If the quenching medium is to be kept continuously at a high temperature, a tank insulation with or without cover is recommended.

Based on Siemens PLC technology the system is operated conveniently with PC-based Nabertherm Control Center software. Components can also be moved manually via a Mobile Panel.

Customized drop-bottom designs are tailored and manufactured to customer needs.

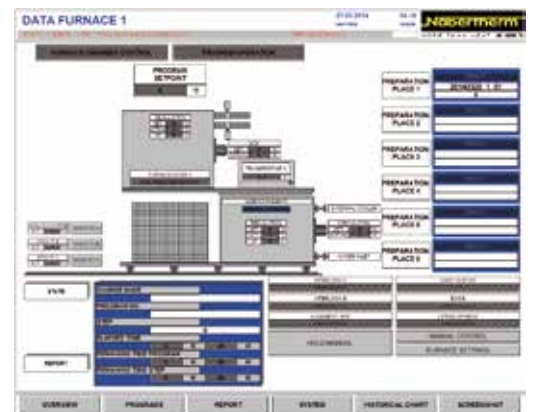

Control, visualization and documentation with Nabertherm Control Center NCC

Size examples Model	Tmax °C	Work space dimensions in mm			Volume in l	Outer dimensions in mm		Heating power in kW ¹	Electrical connection*
		w	d	h		H			
FS 2000/60HAS	600	800	1200	1200	2000	5377**		72	3-phase
FS 2200/60HAS	600	1100	1100	1100	2200	5550**		84	3-phase
FS 5350/60AS	600	1400	1400	1200	5350	7524**		196	3-phase
FS 5670/60AS	600	1500	1500	1350	5670	6452***		196	3-phase

¹Depending on furnace design connected load might be higher

*Please see page 81 for more information about supply voltage
 **with quench tank on cart
 ***with quench tank in a pit

Quench and Temper Plants for Steel



Fully automated tempering plant with two chamber furnaces, quench bath, conveyor system, and parking spots for four charge baskets



Annealing furnace with manipulator

To temper steel, after annealing the furnace is opened at working temperatures of more than 1000 °C. The lift door opens and the manipulator places the charge into the quenching medium. After quenching the charge is placed into the forced convection chamber furnace for tempering. Good temperature uniformity is important.

Oil or water is used as a quenching medium. Depending on the steel grade and the required cooling rate, the charge can also be force-cooled or quenched in an air quenching chamber.

Alternative plant designs are tailored to process requirements. For lighter charge weights a manual tempering plant can be used, consisting of an annealing furnace, quench tank and manual manipulator. Semi-automatic or fully automatic plants are used for heavy loads and high throughput rates. The charge is placed into the hot furnace and subsequently into the quench tank by a manipulator.

The customer specifies the needed quenching delay time for the individual process counting from opening the furnace door until the charge is completely immersed in the quenching medium. Fast delay times are only possible with a powered manipulator. If the quenching delay time is not so critical, for example for heavy and thick-walled parts, bogie hearth furnaces can also be used. The bogie is driven out of the furnace electrically and the components can be transferred and quenched by a crane.



Tempering plant with top hat furnace H 4263/12S and water bath

Top hat furnaces are suitable for long components or for processes with no need for short quenching delay times. The top hat is opened while the furnace is hot and the charge is then transferred and quenched by the customer's crane with a C-hook.

Annealing Furnace Design Alternatives

- Chamber furnace with radiation heating and a lift door for charging with a manipulator
- Bogie hearth furnace with powered bogie for charging with a crane for low quenching delay time requirements
- Top hat furnace for long components, such as rod material for charging with a crane and C-hook

Quenching Design Alternatives

- Quench tanks with water, oil or polymer as a quenching medium see page 57
- Cooling station with powerful fan cooling for air quenching.

Charge Transfer Alternatives

- Manual manipulator for manual tempering plants
- Electric manipulator for manual tempering plants
- Rail-mounted 2-axle manipulator, semi-automatic for charging, unloading and quenching the charge in a liquid medium
- Rail-mounted 2-axle manipulator, semi-automatic or fully automatic for charging, unloading, quenching, subsequent tempering in forced convection furnace or transferring to a holding position



The charge is placed in the hot furnace by a manipulator and is also removed and transferred to the quenching medium while it is hot.

Temperature Uniformity and System Accuracy



Holding frame for measurement of temperature uniformity

Temperature uniformity is defined as the maximum temperature deviation in the work space of the furnace. There is a general difference between the furnace chamber and the work space. The furnace chamber is the total volume available in the furnace. The work space is smaller than the furnace chamber and describes the volume which can be used for charging.

Specification of Temperature Uniformity in +/- K in the Standard Furnace

In the standard design the temperature uniformity is specified in +/- K at a defined set-temperature with the work space of the empty furnace during the dwell time. In order to make a temperature uniformity survey the furnace should be calibrated accordingly. As standard our furnaces are not calibrated upon delivery.

Calibration of the Temperature Uniformity in +/- K

If an absolute temperature uniformity at a reference temperature or at a defined reference temperature range is required, the furnace must be calibrated appropriately. If, for example, a temperature uniformity of +/- 5 K at a set temperature of 750 °C is required, it means that measured temperatures may range from a minimum of 745 °C to a maximum of 755 °C in the work space.

System Accuracy

Tolerances may occur not only in the work space, they also exist with respect to the thermocouple and in the controls. If an absolute temperature uniformity in +/- K at a defined set temperature or within a defined reference working temperature range is required, the following measures have to be taken:

- Measurement of total temperature deviation of the measurement line from the controls to the thermocouple
- Measurement of temperature uniformity within the work space at the reference temperature or within the reference temperature range
- If necessary, an offset is set at the controls to adjust the displayed temperature at the controller to the real temperature in the furnace
- Documentation of the measurement results in a protocol



Pluggable frame for measurement for forced convection chamber furnace N 7920/45 HAS

Temperature Uniformity in the Work Space incl. Protocol

In standard furnaces a temperature uniformity is guaranteed as +/- K without measurement of temperature uniformity. However, as additional feature, a temperature uniformity measurement at a reference temperature in the work space compliant with DIN 17052-1 can be ordered. Depending on the furnace model, a holding frame which is equivalent in size to the charge space is inserted into the furnace. This frame holds thermocouples at defined measurement positions (11 thermocouples with square cross-section, 9 thermocouple with circular cross-section). The temperature uniformity measurement is performed at a reference temperature specified by the customer at a pre-defined dwell time. If necessary, different reference temperatures or a defined reference working temperature range can also be calibrated.



Precision of the controls, e.g. +/- 1K

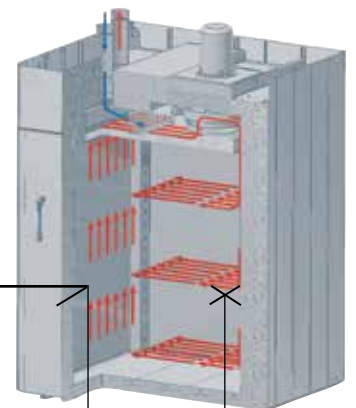

Deviation of thermocouple, e.g. +/- 1.5 °C

Deviation from measuring point to the average temperature in the work space e.g. +/-3 °C

The system accuracy is defined by adding the tolerances of the controls, the thermocouple and the work space

AMS 2750 E, NADCAP, CQI-9

Standards such as the AMS 2750 E (Aerospace Material Specifications) are applicable for the industrial processing of high-quality materials. They define industry-specific requirements for heat treatment. Today, the AMS 2750 E and derivative standards such as AMS 2770 for the heat treatment of aluminum are the guidelines for the aerospace industry. After the introduction of the CQI-9, the automotive industry has also committed to submit heat treatment processes to stricter rules. These standards describe in detail the requirements applicable to thermal processing plants.

- Temperature uniformity in the work space (TUS)
- Instrumentation (definition of measurement and control systems)
- Calibration of the measurement system (IT) from the controller via the measurement line to the thermocouple.
- Inspections of system accuracy (SAT)
- Documentation of the inspection cycles

Norm compliance is necessary to ensure that the required quality standard of the manufactured components can also be reproduced in series. For this reason, extensive and repeated inspections as well as controls of the instrumentation, including the relevant documentation, are required.

Furnace Class and Instrumentation Requirements of the AMS 2750 E

Depending on the quality requirements of heat treatment job the customer specifies instrumentation type and the temperature uniformity class. The instrumentation type describes the necessary combination of the applied control, recording media as well as thermocouples. The temperature uniformity of the furnace and the class of the selected instrumentation are defined based on the required furnace class. The higher the requirements are set for the furnace class the more precise the instrumentation must be.

Instrumentation	Type					Furnace class	Temperature uniformity	
	A	B	C	D	E		°C	°F
Each control zone has a thermocouple connected to the controller	x	x	x	x	x	1	+/- 3	+/- 5
Recording of the temperature measured by the control thermocouple	x	x	x	x		2	+/- 6	+/- 10
Sensors for recording the coldest and hottest spots	x		x			3	+/- 8	+/- 15
Each control zone has a charge thermocouple with recording system	x	x				4	+/- 10	+/- 20
Each control zone has an over-temperature protection unit	x	x	x	x		5	+/- 14	+/- 25
						6	+/- 24	+/- 50

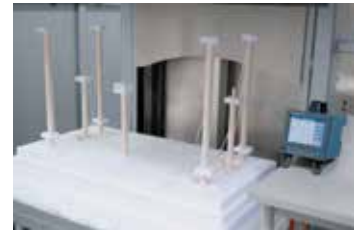

Measurement set-up in a high-temperature furnace



Measurement set-up in an annealing furnace

Regular Inspections

The furnace or the heat treatment plant must be designed so that the requirements of the AMS 2750 E can be met and be reproduced. The standard also requires the inspection intervals for the instrumentation (SAT = System Accuracy Test) and the temperature uniformity of the furnace (TUS = Temperature Uniformity Survey). The SAT/TUS tests must be performed by the customer with measuring devices and sensors which operate independently of the furnace instrumentation.

Nabertherm Services

The suitable furnace model for the corresponding heat treatment can be designed based on the process, the charge, the required furnace class and the type of instrumentation. Depending on the required specs, alternative solutions can be offered.

- Furnace designs, which meet standards, following customer specifications regarding furnace class and instrumentation, incl. gauge connections for repeated customer inspections at regular intervals. No consideration of requirements with respect to documentation
- Data recording devices (e.g., temperature recorder) for TUS and/or SAT measurements see page 82
- Data recording, visualization, time management via the Nabertherm Control Center (NCC), based on Siemens WinCC software see page 80
- Commissioning at site, incl. the first TUS and SAT inspection
- Connection of existing furnace plant to meet norm requirements
- Documentation of the complete process chain in line with the corresponding norm

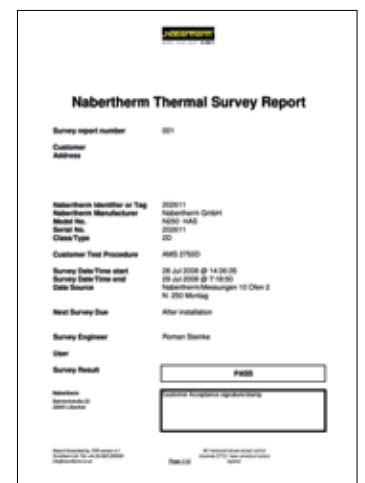

AMS 2750 E, NADCAP, CQI-9



Implementation of AMS 2750 E

Basically, two different systems are available for control and documentation, a proven Nabertherm system solution or instrumentation using Eurotherm controllers/temperature recorders. The Nabertherm AMS package is a convenient solution that includes the Nabertherm Control Center for control, visualization, and documentation of the processes and test requirements based on PLC control.

Instrumentation with Nabertherm Control Center (NCC) for Control, Visualization, and Documentation based on a Siemens PLC Controls

The attractive feature of the instrumentation with Nabertherm Control Center in combination with PLC controls of the furnace is the convenient data input and visualization. The software programming is structured in a way that both the user and the auditor can navigate it without difficulty.

In daily use, the following product characteristics stand out:

- Very easy to navigate and straight-forward presentation of all the data in plain text on the PC
- Automatic saving of the charge documentation at the end of the program
- Administration of the calibration cycles in the NCC
- Results of the measurement distance calibration are entered in the NCC
- Schedule management of the required testing cycles including a reminder function. The testing cycles for TUS (Temperature Uniformity Survey) and SAT (System Accuracy Test) are entered in days and monitored by the system and the operator or tester is informed in time about up-coming tests. The values of the tests are entered directly into NCC and saved as PDF files on the PC. There are no additional tasks involved in documenting the tests.
- Option of transferring the measurement data to a customer's server

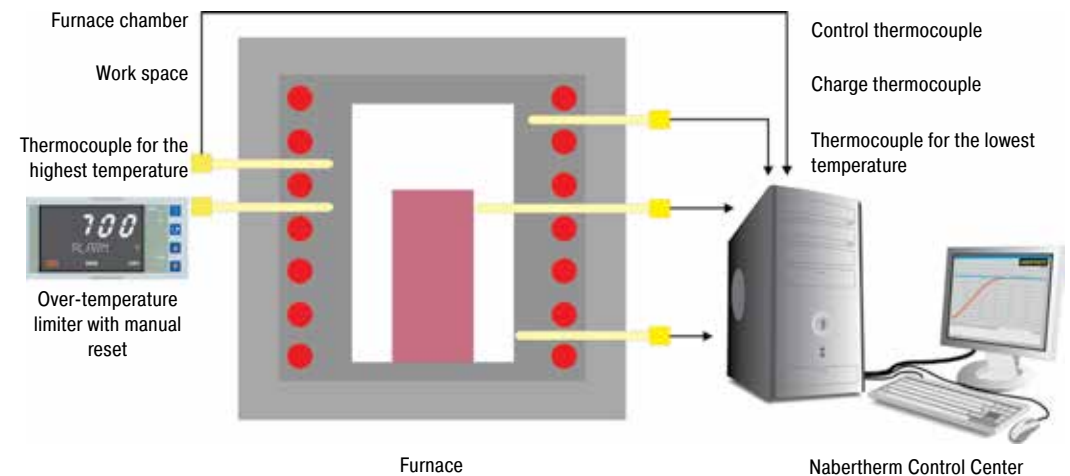

Example of a design with Type A Nabertherm Control Center



The Nabertherm Control Center can be extended to enable a complete documentation of the heat treatment process apart from just the furnace data. For example, when heat-treating aluminum, in addition to the furnace, the temperatures in the quenching basin or a separate cooling medium can also be documented.

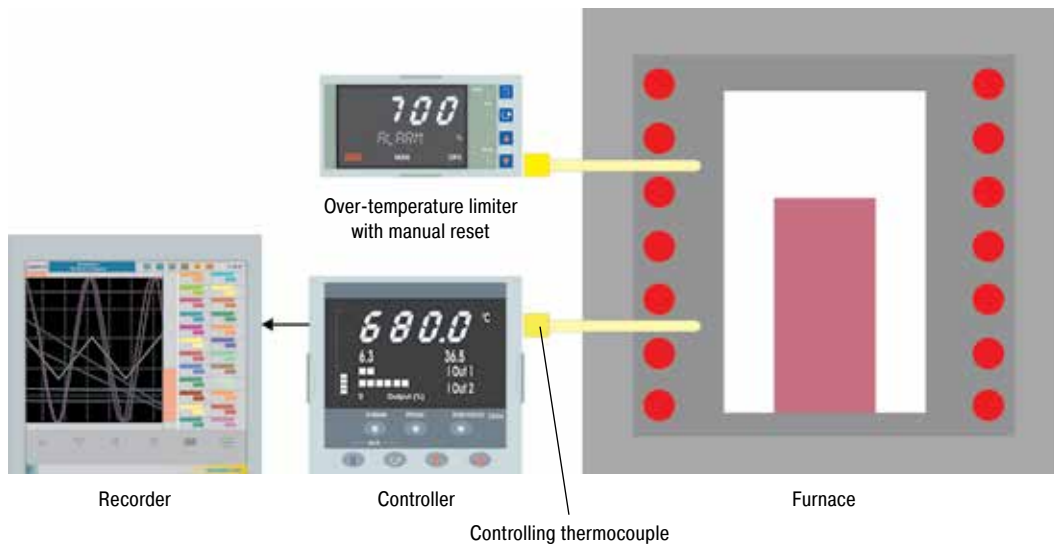

Example of a design containing Type D Eurotherm instrumentation

Alternative Instrumentation with Temperature Controllers and Recorders from Eurotherm

As an alternative to instrumentation with the Nabertherm Control Center (NCC) and PLC controls, instrumentation with controllers and temperature recorders is also available. The temperature recorder has a log function that must be configured manually. The data can be saved to a USB stick and be evaluated, formatted, and printed on a separate PC. Besides the temperature recorder, which is integrated into the standard instrumentation, a separate recorder for the TUS measurements is needed (see page 80).



N 12012/26 HAS1 according to AMS 2750 E

Process Control and Documentation



B400/C440/P470



B410/C450/P480

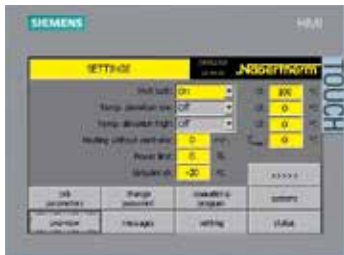

H1700 with colored, tabular depiction



H3700 with colored graphic presentation

Nabertherm has many years of experience in the design and construction of both standard and custom control alternatives. All controls are remarkable for their ease of use and even in the basic version have a wide variety of functions.

Standard Controllers

Our extensive line of standard controllers satisfies most customer requirements. Based on the specific furnace model, the controller regulates the furnace temperature reliably and is equipped with an integrated USB-interface for documentation of process data (NTLog/NTGraph).

The standard controllers are developed and fabricated within the Nabertherm group. When developing controllers, our focus is on ease of use. From a technical standpoint, these devices are custom-fit for each furnace model or the associated application. From the simple controller with an adjustable temperature to the control unit with freely configurable control parameters, stored programs and PID microprocessor control with self-diagnosis system, we have a solution to meet your requirements.

HiProSystems Control and Documentation

This professional process control with PLC controls for single and multi-zone furnaces is based on Siemens hardware and can be adapted and upgraded extensively. HiProSystems control is used when more than two process-dependent functions, such as exhaust air flaps, cooling fans, automatic movements, etc., have to be handled during a cycle, when furnaces with more than one zone have to be controlled, when special documentation of each batch is required and when remote service is required. It is flexible and is easily tailored to your process or documentation needs.

Alternative User Interfaces for HiProSystems

Process control H500/H700

This basic panel accommodates most basic needs and is very easy to use. Firing cycle data and the extra functions activated are clearly displayed in a table. Messages appear as text. Data can be stored on a USB stick using the „NTLog Comfort“ option (not available for all H700).

Process control H1700

Customized versions can be realized in addition to the scope of services of the H500/H700

Process control H3700

Display of functions on a large 12" display. Display of basic data as online trend or as a graphical system overview. Scope as H1700

Control, Visualisation and Documentation with Nabertherm Control Center NCC

Upgrading the HiProSystems-Control individually into a PC-based NCC provides for additional interfaces, operating documentation, and service benefits in particular for controlling furnace groups including charge beyond the furnace itself (quenching tank, cooling station etc.):

- Recommended for heat treatment processes with extensive requirements in respect to documentation e.g. for metals, technical ceramics or in the medicine field
- Software extension can be used also in accordance with the AMS 2750 E (NADCAP)
- Documentation according to the requirements of Food and Drug Administration (FDA), Part 11, EGV 1642/03 possible
- Charge data can be read in via barcodes
- Interface for connection to overriding systems
- Connection to mobile phone or stationary network for malfunction message transmission via SMS
- Control from various locations over the network
- Measurement range calibration up to 18 temperatures per measuring point for use at different temperatures. For norm-relevant applications a multilevel calibration is possible.

Assignment of Standard Controllers to Furnace Families	NRA 17/06 - NRA 1000/11	NR, NRA .. H ₂	NR, NRA .. IDB	SRA	(S/LB) VHT	(S/LB) SVHT ..H ₂	NRA 40/02 CDB	NRA 150/02 CDB	NA 30/45 - N 675/85 HA	N ..26 HA - N ..85 HA	KTR	TR	TR .. LS	SAL	SAH	W .. A	W	WB	NB	N 7/H - N 87 ..H ../HR	N 81(..) - N 641(..)	N 731 - N 2401	NB .. CL	N(B) .. BO	H	TS	QS	DH	D .. S
Catalog page	12	14	14	15	16-21	20	22	22	24	26	32	36	36	39	40	42	44	47	48	49	49	50	52	53	54	60	61	62	68
Controller																													
R7												●																	
B400									●	●	●			●	○	●			●	●	●	●					●		
B410												○																	
C440									○	○	○	○		○	○	○			○	○	○	○					○		
C450																													
P470	●			●	● ³				○	○	○	○		○	○	○	●		○	○	○	○			●				
P480									○	○	○	○		○	○	○													
3208/C6									○	○	○	○		○	○	○												●	●
3504	○			○					○	○	○	○		○	○	○		● ³								●			
H500/SPS									○	○	○	○		○	○	○													
H700/SPS					● ³				○	○	○	○		○	○	○										○	○		
H1700/SPS			●	○			●		○	○	○	○		○	○	○		● ³					●	●	○	○	○	○	○
H3700/SPS	○	●	○	○	○	○	○	○	○	○	○	○		○	○	○		○							○	○	○	○	○
NCC	○	○	○	○	○	○	○	○	○	○	○	○		○	○	○		○							○	○	○	○	○

Functionality of the Standard Controllers	R7	C6	3216	3208	B400/ B410	C440/ C450	P470/ P480	3504	H500	H700	H1700	H3700	NCC
Number of programs	1	1	1		5	10	50	25	20	1/10 ³	10	10	50
Segments	1	2	8		4	20	40	500 ³	20	20	20	20	20
Extra functions (e.g. fan or autom. flaps) maximum					2	2	2-6	2-8 ³	3 ³	○ ³	6/2 ³	8/2 ³	16/4 ³
Maximum number of control zones	1	1	1	1	1	1	3	2 ^{1,2}	1-3 ³	○ ³	8	8	8
Drive of manual zone regulation					●	●	●						
Charge control/bath control							●	○	○	○	○	○	○
Auto tune			●	●	●	●	●	●					
Real-time clock					●	●	●		●	●	●	●	●
Plain, blue-white LC-display					●	●	●						
Graphic color display					●	●	●		4" 7"	7"	7"	12"	19"
Status messages in clear text				●	●	●	●	●	●	●	●	●	●
Data entry via touchpanel					●	●	●		●	●	●	●	●
Data input via jog dial and buttons					●	●	●						
Entering program names (i.e. "Sintering")					●	●	●						●
Keypad lock					●	●	●	●	●				
User administration					●	●	●	●	○	○	○	○	●
Skip-button for segment jump					●	●	●	●	●	●	●	●	●
Program entry in steps of 1 °C or 1 min.	●		●	●	●	●	●	●	●	●	●	●	●
Start time configurable (e.g. to use night power rates)			●	●	●	●	●	●	●	●	●	●	●
Switch-over °C/F	○		○	○	●	●	●	○	●	● ³	● ³	● ³	● ³
kWh meter					●	●	●						
Operating hour counter					●	●	●		●	●	●	●	●
Set point output				○	●	●	●	○		○	○	○	○
NTLog Comfort for HiProSystems: Recording of process data on an external storage medium					●	●	●		○	○	○	○	
NTLog Basic for Nabertherm controller: recording of process data with USB-flash drive					○	○	○						
Interface for VCD software					○	○	○		●	●	●	●	●
Malfunction memory					●	●	●						●

¹ Not for melt bath control
² Control of additional separate slave regulators possible
³ Depending on the design

● Standard
○ Option

Mains Voltages for Nabertherm Furnaces

1-phase: all furnaces are available for mains voltages from 110 V - 240 V at 50 or 60 Hz.
 3-phase: all furnaces are available for mains voltages from 200 V - 240 V or 380 V - 480 V, at 50 or 60 Hz.
 The connecting rates in the catalog refer to the standard furnace with 400 V (3/N/PE) respectively 230 V (1/N/PE).

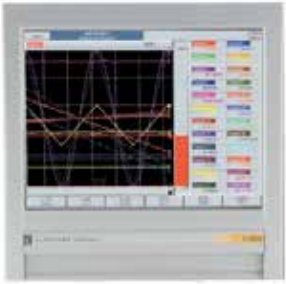

Temperature recorder

Temperature Recorder

Besides the documentation via the software which is connected to the controls, Nabertherm offers different temperature recorders which can be used with respect to the application.

	Model 6100e	Model 6100a	Model 6180a
Data input using touch panel	x	x	x
Size of colour display in inch	5.5	5.5	12.1
Number of thermocouple inputs	3	18	48
Data read-out via USB-stick	x	x	x
Input of charge data		x	x
Evaluation software included	x	x	x
Applicable for TUS-measurements acc. to AMS 2750 E			x



Data storing of Nabertherm controllers with NTLog Basic

NTLog Basic allows for recording of process data of the connected Nabertherm Controller (B400, B410, C440, C450, P470, P480) on a USB stick.

The process documentation with NTLog Basic requires no additional thermocouples or sensors. Only data recorded which are available in the controller.



The data stored on the USB stick (up to 80,000 data records, format CSV) can afterwards be evaluated on the PC either via NTGraph or a spreadsheet software used by the customer (e.g. MS Excel).

For protection against data manipulation the generated data records contain checksums.



NTLog Comfort for data recording of a Siemens PLC

Data storing of HiProSystems with NTLog Comfort

The extension module NTLog Comfort offers the same functionality of NTLog Basic module. Process data from a HiProSystems control are read out and stored in real time on a USB stick (not available for all H700 systems). The extension module NTLog Comfort can also be connected using an Ethernet connection to a computer in the same local network so that data can be written directly onto this computer.

Visualization with NTGraph

The process data from NTLog can be visualized either using the customer's own spreadsheet program (e.g. MS-Excel) or NTGraph (Freeware). With NTGraph Nabertherm provides for a user-friendly tool free of charge for the visualization of the data generated by NTLog. Prerequisite for its use is the installation of the program MS Excel for Windows (version 2003/2010/2013). After data import presentation as diagram, table or report can be chosen. The design (color, scaling, reference labels) can be adapted by using prepared sets.

NTGraph is available in seven languages (DE/EN/FR/SP/IT/CH/RU). In addition, selected texts can be generated in other languages.

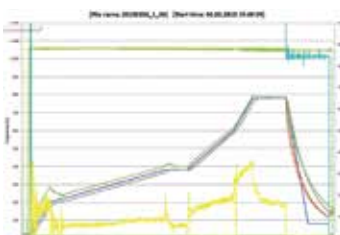

NTGraph, a freeware for the easy-to-read analysis of recorded data using MS Excel

VCD-Software for Visualization, Control and Documentation

Documentation and reproducibility are more and more important for quality assurance. The powerful VCD software represents an optimal solution for single multi furnace systems as well as charge documentation on the basis of Nabertherm controllers.

The VCD software is used to record process data from the controllers B400/B410, C440/C450 and P470/P480. Up to 400 different heat treatment programs can be stored. The controllers are started and stopped via the software. The process is documented and archived accordingly. The data display can be carried-out in a diagram or as data table. Even a transfer of process data to MS Excel (.csv format *) or the generation of reports in PDF format is possible.



VCD Software for Control, Visualisation and Documentation



Example lay-out with 3 furnaces

Features

- Available for controllers B400/B410/C440/C450/P470/P480
- Suitable for operating systems Microsoft Windows 7 (32/64 Bit) or 8/8.1 (32/64 Bit)
- Simple installation
- Setting, Archiving and print of programs and graphics
- Operation of controllers via PC
- Archiving of process curves from up to 16 furnaces (also multi-zone controlled)
- Redundant saving of archives on a server drive
- Higher security level due to binary data storage
- Free input of charge date with comfortable search function
- Possibility to evaluate data, files can be converted to Excel
- Generation of a PDF-report
- 17 languages selectable

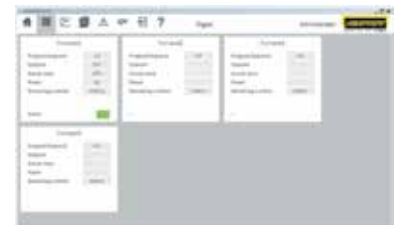

Graphic display of main overview (version with 4 furnaces)

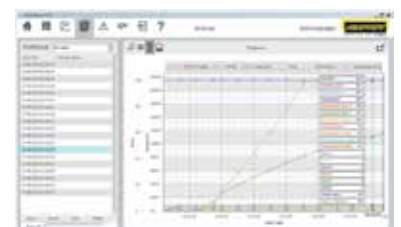

Graphic display of process curve

Represent by



CONTACT US

Prolific Heating International Co., Ltd.

11/11 Moo 11 Rachathava, Bangplee, Samutprakarn 10540 Thailand.

Tel: +662-170-8171 (Auto 6 lines), Fax: +662-170-8178,9

+668-1914-8971 (Thailand),

+668-7705-6200 (International)

E-mail: hathairat@phiheating.com (Thai) ,
merry@phiheating.com (English),
jolie@phiheating.com (Vietnamese)

SCAN ME



www.phiheating.com

■ Made
■ in
■ Germany